

Kaskadenkonstruktionen / Flower Towers



where nature doesn't reach...

Model **H700** 18/25

Model **H750** 26/33

Model **H1100** 34/41

Model **H1200** 42/51

Model **H1200** ^{1/2} ^{1/4} ^{1/2} 52/61

Model **H2000** 62/69

Model **H2000**^{1/2} 70/71

Model **H2400** 72/79

Model **H3000** 80/87

Model **W600** 88/95

New **models** 100

40.000

products sold worldwide

over 18 YEARS

of experience

in the creation of urban space

Die höchste Priorität für die Firma Terra hat die Versorgung der Kunden mit innovativen und effektiven technologischen Lösungen für das Wachstum der Pflanzen. Dank der Verbindung des Wissens von Produktionsexperten, Designern und Landschaftsarchitekten sind Terra-Produkte immer innovative Lösungen von höchster Qualität.

The priority of Terra is designing and production of innovative and effective technological solutions in plant growing. Thanks to the integration of the knowledge of technologists, designers and landscape architects, the products of Terra are always inventive tools with high quality.



we are the LEADER

in the production of innovative tools
for urban space shaping

Produkte der Firma Terra finden Sie in Städten, Dörfern, Parks, Wohnvierteln, Einkaufszentren, Bahnhöfen, Hotels usw. Diese innovativen Produkten werden in ganz Europa und sogar weltweit verwendet. Sie tragen zur Verschönerung vieler Städte bei und verleihen ihnen einen einmaligen Charakter. Sie bringen Farben in solche Städte wie Berlin, Casablanca, Wien, Riga, Wrocław oder Poznań...

You'll find the products of Terra in urban and rural spaces, parks, shopping centres, bus and train stations, hotels etc. These inventive products are used in the whole Europe and in the world. They contribute to decorate such famous places as Krakowskie Przedmieście in Warsaw and Piotrkowska Street in Łódź. They also bring colours to the biggest cities like Berlin, Casablanca, Vienna, Riga, Wrocław and Poznań...

One company...

Ich erinnere mich genau an dieses Jahr...

1998

In Disneyland zog eine schöne Ansicht meine Aufmerksamkeit: ein Platz wurde mit hohen Blumenpyramiden verschönert. Diese Landschaft, die sich so stark von der polnischen Eintönigkeit der 90er Jahre unterschied, blieb mir in Gedächtnis haften. So entstand eine Idee... Genau das fehlt in Polen! Dieser Gedanke schwebte mir die ganze Rückreise lang vor. Ich bat meinen Vater-Ingenieur um Hilfe. In einer kleinen, am Haus gelegenen Werkstatt begannen wir enthusiastisch die Arbeit...

1999

Die Versuch-Irrtum-Etappe schien ewig zu dauern. Prototypen sahen nicht so gut aus. Nach vielen Versuchen gelang es uns, die erste Kaskadenkonstruktion zu schaffen. Das erste Modell H2400 habe ich mit meinem Vater bepflanzt. Das war etwas Ungewöhnliches!

2000

In neues Jahrtausend trat ich mit Hoffnung und Optimismus ein. Ich begann, unsere Pläne zu bewerben. Endlich kam diese Zeit – für unsere Produkte hat sich die Stadtverwaltung in Wrocław und Duszynki-Zdrój entschieden.

2002

Im Laufe der Zeit ergab es sich, dass zwei Modelle nicht ausreichend sind. Jeder Kunde hat doch andere Bedürfnisse. Ich führte tausende Gespräche... ich vervollkommnete bestehende Produkte und führte in das Angebot neue Modelle (H750 und H1100) ein.

2004

101... ich mag seit immer die Zahlen. Diese Zahl war für mich besonders wichtig. Im Juni haben wir die Grenze der 100 verkauften Produkte überschritten!

2007

Vor drei Jahren trat Polen der Europäischen Union bei, was neue Möglichkeiten eröffnete. In diesem Jahr wurde die erste Bestellung in Deutschland realisiert.

2008

2008 - 1001... wenn ich durch Polen reise, sehe ich immer häufiger unsere Produkte. Vor kurzem träumte ich nur von Veränderungen, jetzt kann ich sie beobachten. Wir haben 1001 Produkte verkauft. Das ist 1001 positive Änderungen! Unsere Kaskadenkonstruktionen wurden u.a. auf internationaler Messe in Posen ausgezeichnet.



FLORAS AWARDS

I perfectly remember this year...

1998

It was then that I was intrigued by a beautiful view in Disneyland Paris – a square decorated with high pyramids planted with flowers. I still remember this picture, so different from Polish greyness of the 90s. And a certain idea came to my mind... This was it what Poland needed! This thought accompanied me all the way home. I asked my father, an engineer, for help. Equipped with enthusiasm and the vision of urban space change, we started working in a small backyard workshop...

1999

The stage of trial and error lasted endlessly. Although the prototypes didn't look impressive, we managed to create the Flower Tower. We planted the very first H2400 model with flowers. That was something!

2000

I stepped in the new millennium full of optimism and hope. I began promoting our vision of the change of Polish cities. Finally, the day has come – municipal authorities of Wrocław and Duszynki-Zdrój decided to use our products.

2002

With time it turned out that two models weren't enough – each client had their own needs. I talked and listened... Based on those conclusions, I improved existing models and introduced two new models, H750 and H1100, to the offer.

2004

101... I've always been keen on numbers, and this one was special for me. In June 2004 our two-person team crossed the ceiling of 100 sold products.

2007

The entry to the European Union opened new possibilities. This year we implemented the first project in Germany.

2008

1001... When I travelled through Poland, I passed by more and more of our products. Not so long ago I had dreamt about beautiful urban space, and then, I was the witness of this transformation. We had sold 1001 products. These were 1001 good changes... Evidence? Our Flower Towers got two awards on international exhibitions.

Bogusław Albinowski
CEO Terra Group

...two stories

Jahrelang beobachtete ich Deine Arbeit...

2009

Wir haben ein Familienunternehmen geschaffen. Die Verbindung der Jugend mit der Erfahrung bedeutete den Anfang der Änderungen...

2010

Ich konzentrierte mich auf Team-Bildung. Firma wird doch von Menschen geschaffen – in Menschen liegt also die Kraft. Wir müssten nicht lange auf Effekte warten. Unsere Produkte kann man auf der ganzen Welt finden – u.a. in Casablanca. Gleichzeitig arbeiten wir an neuen Produkten. Wir führten hängende Kaskadenkonstruktion W600 ein. Sie wurde auf 150 Straßenlaternen in Lodz montiert.

2011

In Zielona Góra entsteht die Filiale – das kreative Herz der Firma. In der Marketingabteilung arbeiten kreative Menschen voller neuen Ideen. Wir eröffnen auch die Filiale in Deutschland.

2012

Ständige Entwicklung ist für uns sehr wichtig, so wird unsere Produktpalette immer breiter. In diesem Jahr bieten wir unseren Kunden auch das Modell H700 an.

2014

5001... über 70% polnische Städte hat sich schon für unsere Lösungen entschieden. Kaskadenkonstruktionen wurden zum festen Element unserer Landschaft. Ich bin stolz auf Menschen, die zusammen mit mir diesen Erfolg verdienen!

2015

Terra ist jetzt eine der vielen Marken, die Terra Group schaffen. Wir beschäftigen über 30 Mitarbeiter und liefern unsere Produkte nach über 500 Städten in Polen, Europa und auf der ganzen Welt. Was wichtig, handeln wir nach den Regeln, die mein Großvater und mein Vater am Anfang bestimmt haben. Empfindlichkeit, Teamarbeit und Loyalität. Wir sind doch Familie...

F
U
B
A
S



I've been observing you for years...

2009

Our family bonds became foundations for creating a family company. The clash of youth with experience was the beginning of a new change...

2010

I focused on team building. People create a company, and people are the strength. We didn't have to wait too long for effects. Our products began reaching to the farthest corners of the world. We won the contract in Casablanca in Morocco. All this time we're working on new products – the result was the new W600 model designed for street lamps. Simultaneously, we carry out the project of the modernisation of Piotrkowska Street in Łódź in Poland where 150 lamps were decorated with W600. That year we also offered a new Full Service – selling constructions with blooming flowers, ready to decorate the city.

2011

Dynamic and original – such people created the branch of Terra in Zielona Góra, Poland. This is the place where we located a creative heart of our company – the marketing department. In this time we also decided to open an office in Germany.

2012

We focused on the development so our product collection was still growing – we welcomed H700 and „the halves“ on board!

2014

5001... more than 70% of Polish cities benefited from our solutions. Flower Towers etched into the landscape of our country permanently. I was proud of people who earned this success together with me!

2015

Nowadays Terra is one of the brands creating Terra Group. Currently we hire over 30 people and we deliver products up to 500 places in Poland, Europe and in the world. It's crucial that we still work in accordance with the principles that guided my father and grandfather at the beginning of this company – sensitivity to the needs of others, team work, and most of all, a sense of unity and loyalty. After all, we're family...

Maciej Albinowski
Managing Director

Do you know that...

► BEWÄSSERUNGSSYSTEM

TERRA CLICK TIF ist ein integriertes, an Kaskaden-Blumenständerkonstruktionen Terra speziell angepasstes System. Es garantiert eine hohe Präzision bei der Bewässerung, reduziert sowohl die Kosten (dank der Anpassung der Wassermenge an die Pflanzenbedürfnisse) als auch den Zeitaufwand, der mit der Pflege verbunden ist.

► KEINE SCHARFEN KANTEN

Bei der Gestaltung von Kaskaden-Blumenständerkonstruktionen Terra wurden alle Elemente, die in irgendeiner Weise der Sicherheit ihrer Benutzer gefährden könnten, eliminiert. Zusätzlich sind die Ringkanten mit Gummidichtung ausgestattet. Gleichzeitig schützen sie die Pflanzen vor den mechanischen Beschädigungen.

► LASERGESCHNITTENE RINGE

Der Laserschnitt, der bei der Ringherstellung angewendet wurde, ist die modernste Methode der Metallbearbeitung. Dank dieser Technologie zeichnen sich unsere Produkte durch höchste Qualität aus.

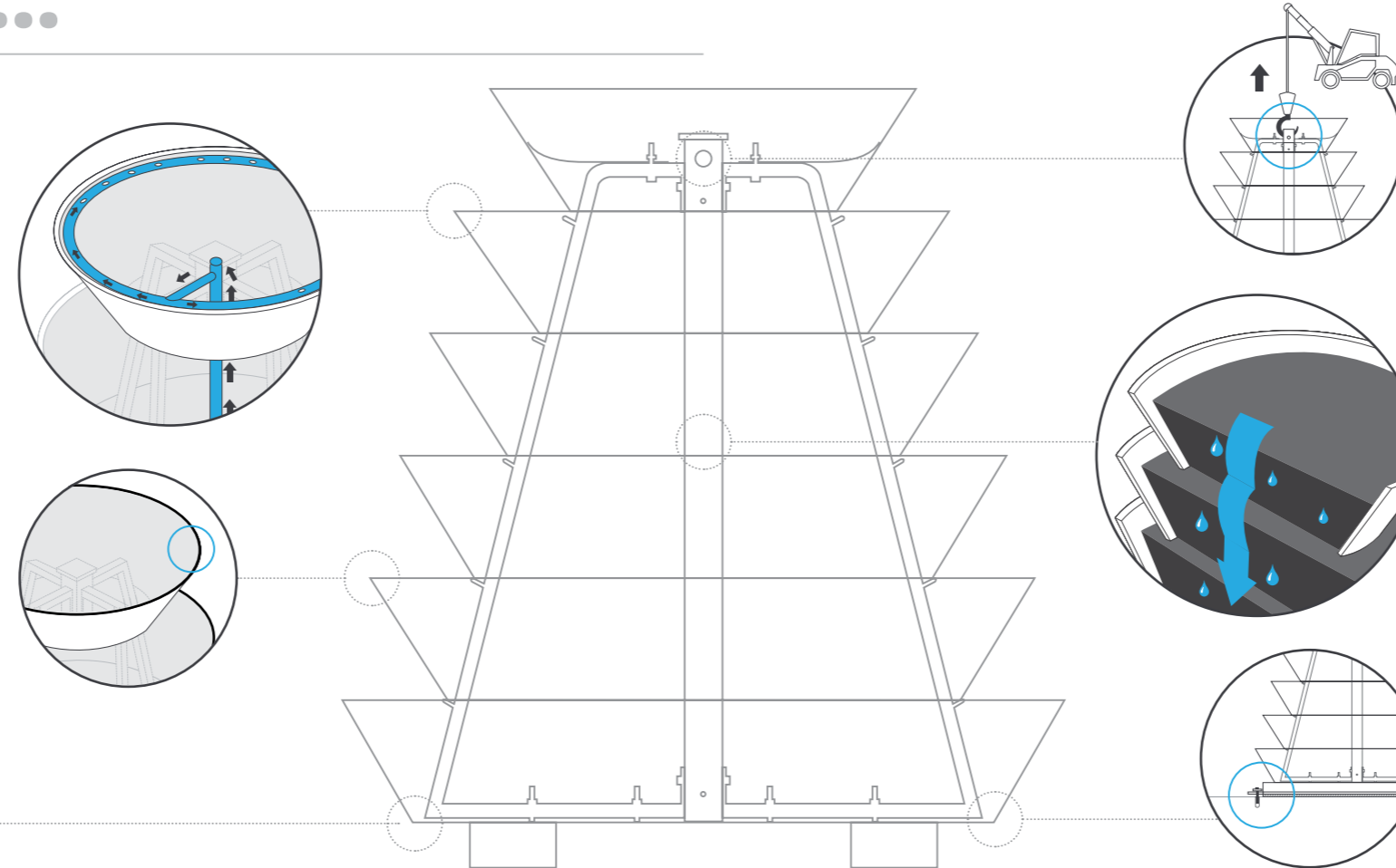

► TRANSPORTMODUL

Funktionales System, das bequeme Entladung der bepflanzt Konstruktoren erleichtert und lässt das Risiko der Blumenbeschädigung reduzieren. Der sichere und widerstandsfähige Griff beschleunigt wesentlich den Prozess der Einführung von Produkten in gewählten Raum.

► KASKADENSYSTEM

Innovative und mit Patent geschützte Lösung, die Effektivität und Qualität des Pflanzenanbaus wesentlich erhöht. Da die einzelnen Schichten der Blumenständerkonstruktion keinen Boden besitzen, haben die Pflanzenwurzeln optimale Wachstumsbedingungen sowie entsprechende Wasser- und Luftmenge.

► DIEBSTAHLSICHERUNG

Sichere und dauerhafte Lösung, die unsere Produkte vor Diebstahl schützt. Dank der stabilen und widerstandsfähigen Bodenbefestigung bleibt die Kaskaden-Blumenständerkonstruktion an ihrem Bestimmungsort.

Do you know that...

▶ WATERING SYSTEM

TERRA CLICK TIF watering installation is an integrated system specially designed for Terra Flower Towers. It provides a high precision of watering, reduces time required for maintenance and saves money thanks to adjusting watering to plant needs.

▶ NO SHARP EDGES

The design of Flower Towers eliminates elements that could be dangerous in use in any possible way. Additionally, the edges of rings are finished with rubber gaskets that also protects plants from mechanical damage.

▶ LASER-CUT RINGS

Laser cutting used in production is the most modern method of metal processing. Thanks to this technology, offered products are characterised by the highest quality of workmanship.

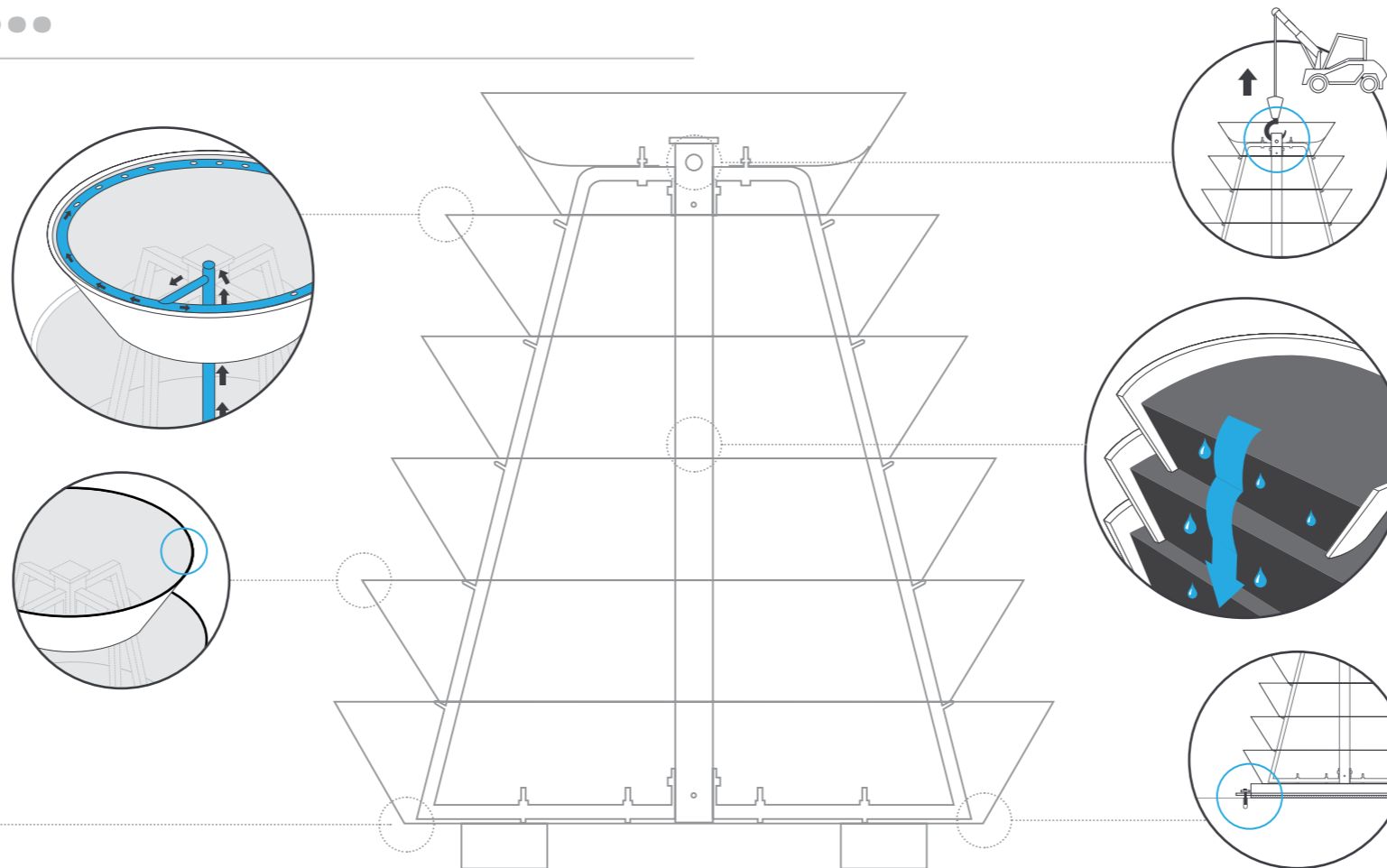

▶ TRANSPORT MODULE

A functional system that make unloading easier and without a risk of plant damage. A safe and durable handle accelerates the process of providing products into urban space.

▶ CASCADE SYSTEM

The innovative and licensed solution that increases the effectiveness and quality of plants. Particular ring layers of a flower tower haven't got bottoms, so roots have ideal grow conditions and optimal amount of water and air.

▶ ANTI-THEFT SYSTEM

The safe and solid solution that eliminates losses caused by robbery. Stable and durable installation to the ground makes constructions immovable.

Do you know that...

► EFFEKT EINER BLÜHENDEN KUGEL

Um die Bedürfnisse der Stadtarchitektur zu befriedigen, hat die Firma Terra Kaskaden-Blumenampeln geschaffen. Diese mit Patent geschützten Produkte sind einzige Blumenbehälter dieser Art in Europa. Voll bepflanzt lassen sie einen ungewöhnlichen Effekt einer blühenden Kugel erzielen.

► BEWÄSSERUNGSSYSTEM + DOPPELTER BODEN

Spezielles Modul der Kontrolle und Versorgung entsprechender Wassermenge direkt zum Wurzelsystem von Pflanzen. Die Überlauflöcher regulieren optimale Wassermenge im Behälter – gleichzeitig verhindern sie das Verwesen der Pflanzen beim Wasserüberfluss. Zusätzliches Bewässerungssystem garantiert nicht nur den Nutzungskomfort, sondern auch lässt die Pflegekosten reduzieren.

► BEFESTIGUNGEN FÜR JEDE STRASSENLATERNE

Breite Befestigungspalette ermöglicht die Montage der Blumenampel an fast jede Straßenlaterne. Spezielle Konstruktion und zur Herstellung der Griffe verwendetes Material garantieren sichere Nutzung und schützen die Außenschicht der Straßenlaterne.

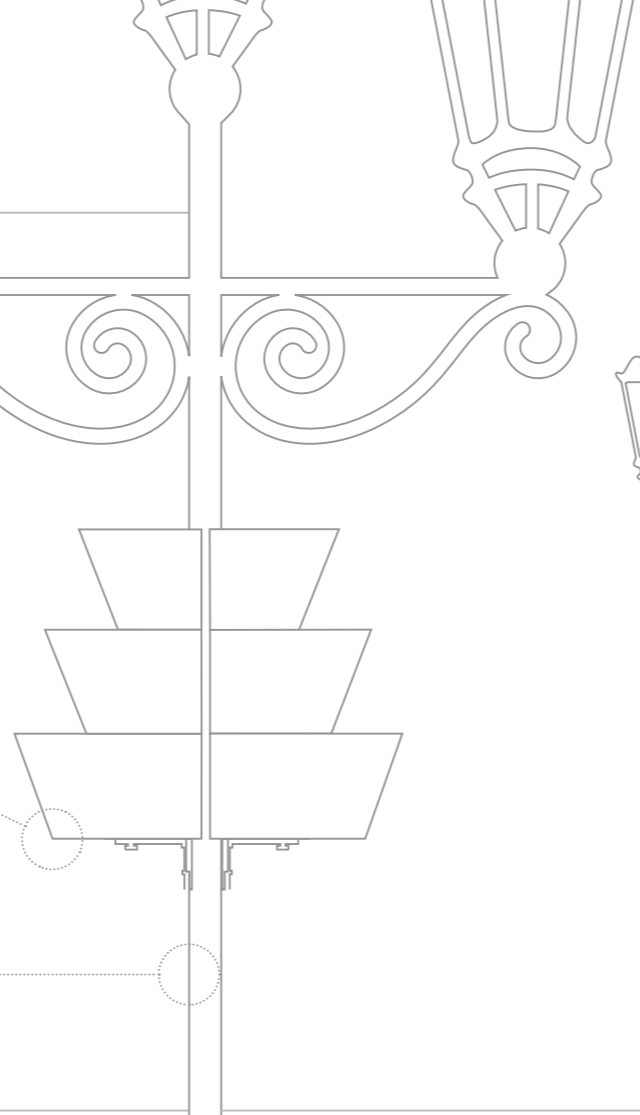
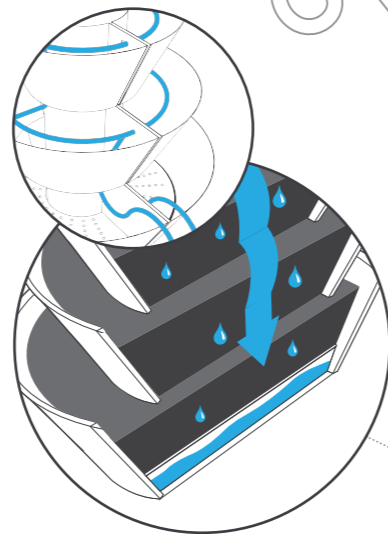

Wählen Sie Ihr Modell



W600

Schaffen Sie eine effektvolle, blühende Kugel auf Straßenlaternen.



**NEUES
MODELL**

W600/2

Schaffen Sie eine blumige Dekoration mit kleinerer Menge der Setzlinge.



**NEUES
MODELL**

W600/1

Erreichen Sie den Effekt einer blumigen Schüssel über den Köpfen der Passanten.

Do you know that...

► THE EFFECT OF FLORAL SPHERE

Thinking about small urban architecture, we created the models designed for lamps. These patent products are the only such containers for flowers in Europe. When they are fully planted, they look like floral spheres.

► WATERING SYSTEM + DOUBLE BOTTOM

A special module that controls and supplies water directly to the root system of plants. Overflow holes regulate optimal amount of water in a container, preventing flowers from rotting if there's too much of it. Additional watering system provides comfort and reduces money spent on maintenance.

► FIXING SUITABLE FOR EVERY LAMP

A wide range of grips enables a fixing of a construction on almost every street lamp. A special structure and material used in grip production guarantees safe use and the lamp coat protection at the same time.

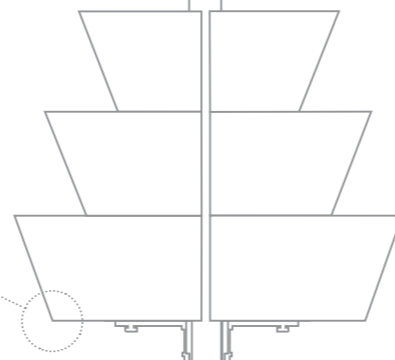
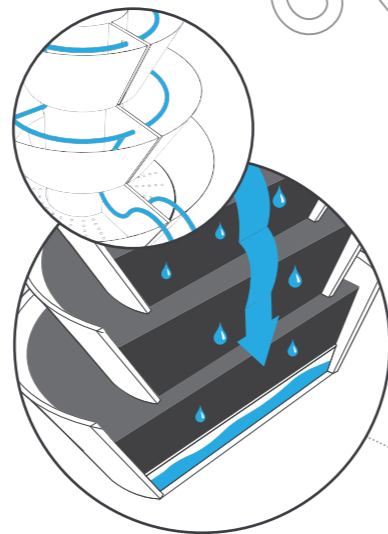

Choose your model



W600

Create a beautiful floral sphere on street lamp lamps.



NEW MODEL

W600/2

Built an impressive floral decoration with a smaller amount of plants.



NEW MODEL

W600/1

Get an interesting effect of a floral bowl above pedestrians' heads.

ÄSTHETISCH UND SICHER
AESTHETIC AND SAFE

www.terraflowertower.eu



KASKADENKONSTRUKTION
FLOWER TOWER

H 700



Die Vorteile dieses kleinen Modells liegen in seiner schlanken Silhouette und großem Fassungsvermögen. In diesem Blumenturm können ungefähr 40 Blumensetzlingen angepflanzt werden. Dank seiner Form einer blumigen Kugel lässt er ein bisschen Farbe in jede Umgebung einführen.

It surprises you with a slim shape and a huge capacity. This smallest model is able to contain about 40 plants. The floral form of a sphere, into which a construction transforms after planting, will add colours to the city and brightens up the area.

☰ 3 levels

📏 105 - 160 kg

💧 167 l

📏 720 mm

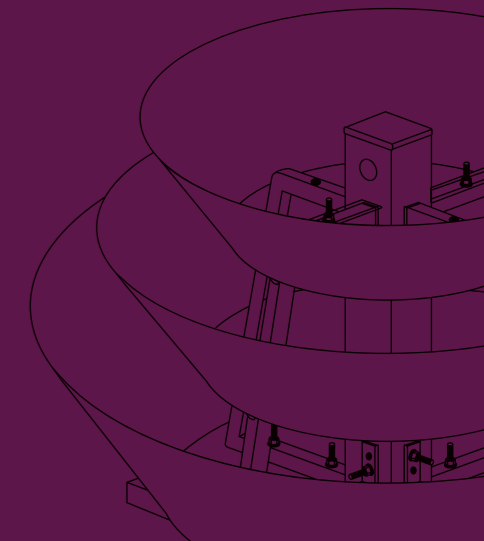



H700, H750, H2000  A121

DENKMAL

Denkmäler spielen eine wichtige Rolle im Stadtraum – sie funktionieren als Gedenkstätten, machen wichtige Ereignisse oder Persönlichkeiten unvergesslich. Aus diesem Grund sollten sie ungewöhnlich dekoriert werden. Betonen Sie ihre Bedeutung mit Kaskadenkonstruktionen.

MONUMENT

Monuments are significant elements in urban space. Such places commemorate crucial events and people that are important to the society and the country, so they need to be representative. Underline their value and accentuate them with the help of Flower Towers.

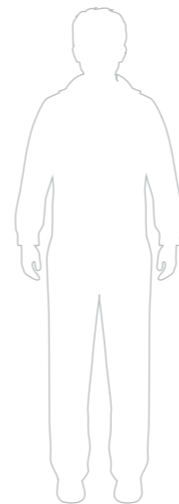

H 700



straße
street



gehweg
pavement













marktplatz
town square



kreisverkehr
roundabout



denkmal
monument

	Anzahl der Ringe levels	▶	3
	Fassungsvermögen capacity	▶	167 l
	Gesamthöhe total height	▶	720 mm
	Basisdurchmesser bottom diameter	▶	750 mm
	Gewicht vor Bepflanzung weight before planting	▶	35 kg
	Gewicht nach Bepflanzung weight after planting	▶	105 - 160 kg
	Anzahl der Setzlinge estimated number of plants	▶	30 - 40
	Basisfarbe basic colour	▶	 030
	Farbvarianten available colours	▶	 032  033  034  035



3 Jahre Garantie
3 year guarantee



Transportmodul
transport module



Bewässerungssystem
watering system



Diebstahlsicherung
anti-theft system



Mobilsystem
mobile system



H700, H1200  A126

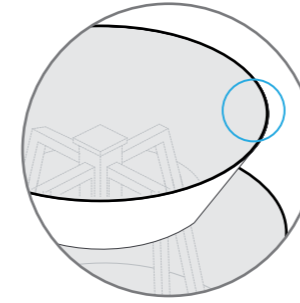

▶ KEINE SCHARFEN KANTEN NO SHARP EDGES

Bei der Gestaltung von Kaskaden-Blumenständerkonstruktionen Terra wurden alle Elemente, die in irgendeiner Weise der Sicherheit ihrer Benutzer gefährden könnten, eliminiert. Zusätzlich sind die Ringkanten mit Gummidichtung ausgestattet. Gleichzeitig schützen sie die Pflanzen vor den mechanischen Beschädigungen.

During designing Flower Tower, we put emphasis on their safe use. Decorations haven't got any sharp fragments or any other elements that could cause danger. The edges of particular rings are finished with rubber gaskets that also minimize the risk of injury and damage to plants.



“Quality and safety cannot be copied”

Der größte Vorteil unserer Produkte liegt in ihrer Qualität. Wir beachten auch die Regeln der Sicherheit, Funktionalität und Ästhetik. Präzise Ausführung und Anwendung der hochwertigen Materialien garantieren problemlose, jahrelange Nutzung der Kaskadenkonstruktionen.

Quality is one of the most valuable features of our products. We maintain it on the highest level, caring about safety, functionality and aesthetics at the same time. The precise workmanship and the best materials guarantee trouble-free and safe use of a construction for years.

Urszula Jarczak 

Kundenbetreuerin | Customer Service Specialist | +49 (0) 30.12 07 46 90 | urszula.jarczak@terra-de.eu



KLEINE KONSTRUKTION, GROSSE MÖGLICHKEITEN
SMALL BUT WITH BIG POSSIBILITIES

www.terraflowertower.eu



KASKADENKONSTRUKTION
FLOWER TOWER

H 750



Niedrige und zugleich ausladende Form der Konstruktion lässt einen einzigartigen Effekt des Blumenhügels erzielen. Dank seiner Höhe passt sich dieses Modell hervorragend an die Mittelfläche von Kreisverkehren, Kreuzungen und Grünanlagen an. Es ist ein ideales Werkzeug zur wirksamen und schnellen Dekoration von Orten, wo traditionelle Bepflanzung unmöglich ist.

This short and branchy construction gives an unusual effect of a mound. Due to its build, it's a suitable decoration for roundabouts, junctions or squares. H750 model is also a perfect tool for effective and fast arrangement of urban space lacking natural ground.

☰ 3 levels



190 - 370 kg



373 l



740 mm

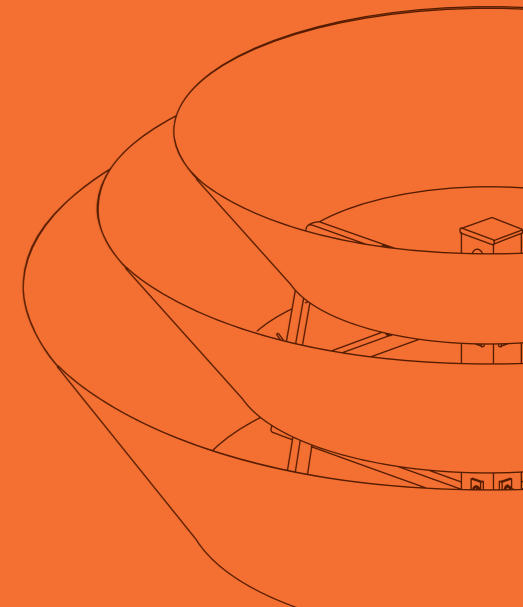



H750  A116, A121

MARKTPLATZ

Den Marktplatz kann man in fast allen europäischen Städten finden. Unabhängig von seiner Größe, Bebauung oder Architektur betont die Stadtverwaltung gerne seinen Charme. Oft ist es jedoch unmöglich, Bäume und Sträucher anzupflanzen. Dieses Problem lösen Kaskadenkonstruktionen. Nutzen Sie das Modell H700 als natürliche Grenze zwischen dem Gehweg und der Straße!

TOWN SQUARE

Almost every city has an old market. Regardless its surface, municipal authorities do their best to accentuate the charm of this place. If traditional planting is impossible, Flower Towers will help. Create natural barriers from traffic thanks to the model H700.

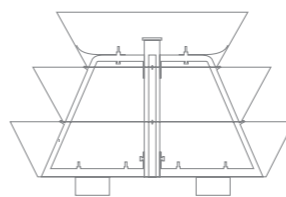
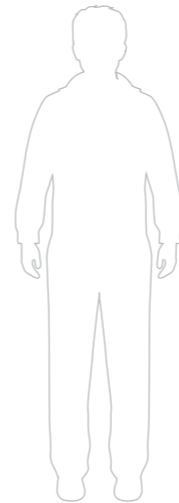

H 750



straße
street

















marktplatz
town square







kreisverkehr
roundabout



denkmal
monument

	Anzahl der Ringe levels	▶	3
	Fassungsvermögen capacity	▶	373 l
	Gesamthöhe total height	▶	740 mm
	Basisdurchmesser bottom diameter	▶	1200 mm
	Gewicht vor Bepflanzung weight before planting	▶	58 kg
	Gewicht nach Bepflanzung weight after planting	▶	190 - 370 kg
	Anzahl der Setzlinge estimated number of plants	▶	40 - 50
	Basisfarbe basic colour	▶	 030
	Farbvarianten available colours	▶	 032  033
			 034  035

-  **3 Jahre Garantie**
3 year guarantee
-  **Transportmodul**
transport module
-  **Bewässerungssystem**
watering system
-  **Diebstahlsicherung**
anti-theft system
-  **Mobilsystem**
mobile system

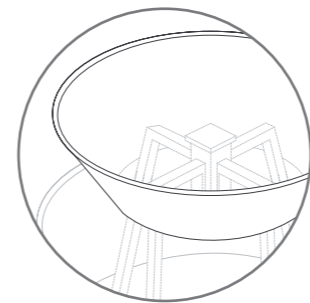

▶ LASERGESCHNITTENE RINGE LASER-CUT RINGS

Der Laserschnitt, der bei der Ringherstellung angewendet wurde, ist die modernste Methode der Metallbearbeitung. Dank dieser Technologie zeichnen sich unsere Produkte durch höchste Qualität aus.

Laser cutting of steel that is applied in the production of Flower Towers is the most modern and effective method of metalworking. The application of this technology guarantees that the rings are perfectly even and without any flaws. The constructions are characterised by the highest quality of workmanship and smooth edges.



“ See before deciding!

Möchten Sie das Arrangement Ihres Raumes sorgfältig planen? Sind Sie gespannt, wie sich Ihre Stadt nach der Einführung der Kaskadenkonstruktionen präsentieren wird? In wenigen Augenblicken schaffen wir eine kostenlose, an Ihre Bedürfnisse angepasste Visualisierung. Kontaktieren Sie uns per visualisation@terraflowertower.eu und schauen Sie sich an, wie wir zusammen Ihren Raum verändern können.

Do you want to plan the appearance of urban space? Do you wonder how your city will look with Flower Towers? We can create a free visualisation adjusted to your needs. Write to us on wizualizacja@terra-pl.eu and see how we can change public space together.

Dominik Osyczka 

Landschaftsarchitekt | Landscape architect | dominik.osyczka@terra-pl.eu



UNIVERSALITÄT ZÄHLT
UNIVERSALITY MATTERS

www.terraflowertower.eu



KASKADENKONSTRUKTION
FLOWER TOWER

H 1100



Diese schlanke Kaskade ist als einzige schon in der Basisversion pulverfarbbeschichtet. Sie ist mobil und montagefreundlich. Sie lässt einen großen Effekt in kleinen Räumen wie z. B. Gehwege erreichen. Dieses Modell präsentiert sich am besten in Begleitung anderer Blumentürme.

A slim cascade, which as the only one, is powder coated in basic version. This model is movable and easy to install. It makes a huge impression in narrow places such as pavement or avenue. Its aesthetic qualities are the most seen when you put several constructions next to one another.

☰ 6 levels

📏 90 - 120 kg

💧 125 l

📏 1010 mm

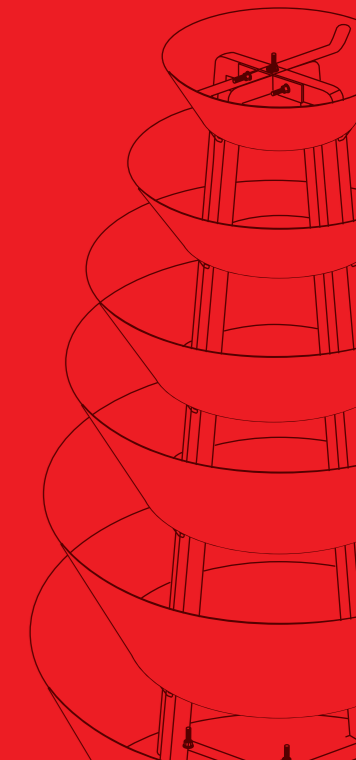



GEHWEG

Um die Gehwege zu verzieren, verwenden Sie schmale Konstruktionen H1100. Dank ihrer Form stören sie den Verkehr nicht und zugleich trennen sie die Fußgängerzone von belebter Straße ab.

PAVEMENT

If you want to decorate pavements, use slim constructions H1100. Thanks to their form, they don't make moving difficult for pedestrians. They also separate them from a busy street.

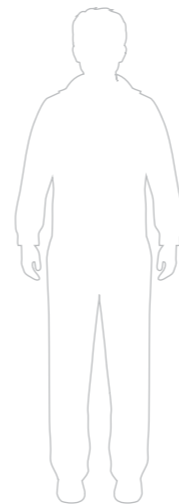

H 1100



marktplatz
town square



park
park



gehweg
pavement



denkmal
monument

	Anzahl der Ringe levels	▶	6
	Fassungsvermögen capacity	▶	125 l
	Gesamthöhe total height	▶	1010 mm
	Basisdurchmesser bottom diameter	▶	600 mm
	Gewicht vor Bepflanzung weight before planting	▶	30 kg
	Gewicht nach Bepflanzung weight after planting	▶	90 - 120 kg
	Anzahl der Setzlinge estimated number of plants	▶	32 - 50
	Basisfarbe basic colour	▶	032
	Farbvarianten available colours	▶	033 034 035



3 Jahre Garantie
3 year guarantee



Bewässerungssystem
watering system



Mobilsystem
mobile system

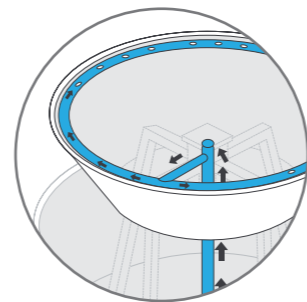

► BEWÄSSERUNGSSYSTEM WATERING SYSTEM

TERRA CLICK TIF ist ein integriertes, an Kaskaden-Blumenständerkonstruktionen Terra speziell angepasstes System. Es garantiert eine hohe Präzision bei der Bewässerung, reduziert sowohl die Kosten (dank der Anpassung der Wassermenge an die Pflanzenbedürfnisse) als auch den Zeitaufwand, der mit der Pflege verbunden ist.

TERRA CLICK TIF watering installation is an integrated system specially designed for Terra Flower Towers. It provides a high precision of watering, reduces time required for maintenance and saves money thanks to adjusting watering to plant needs.



“**Go green!**

Seit fast 2 Jahren unterstützt der Weblog [greenspired.de](http://www.greenspired.de) die Städte, die bunte, natürliche Akzente in Ihre Räume einführen. Jedes Jahr organisieren wir den Wettbewerb Terra Flower Power – Die am schönsten bepflanzte Stadt in Polen. Suchen Sie nach Ideen, wie man das Image Ihrer Stadt verbessern kann? Lassen Sie sich unter www.greenspired.de inspirieren!

We notice the advantages of urban greenery when we miss it... This is why we've supported on our blog "Inspirowani Naturą" ("Inspired by Nature") any activities regarding flowers and nature in cities since three years. If you look for inspirations for your place, visit our site www.inspirowaninatura.pl

Natalia Zalopana 

PR-Spezialistin | Public Relations Specialist | natalia.zalopana@terra-pl.eu



BESTSELLER UNTER ALLEN KASKADENKONSTRUKTIONEN
THE MOST POPULAR MODEL

www.terraflowertower.eu



KASKADENKONSTRUKTION
FLOWER TOWER

H 1200



Diese große, aber nicht besonders hohe Konstruktion zeichnet sich mit Stabilität aus. Dank ihrer Größe kann sie in der Nähe von Bänken und Abfalleimern gestellt werden und so eine einheitliche Komposition mit anderen Elementen der Kleinarchitektur schaffen. Ihre Universalität ist der wichtigste Grund dafür, dass dieses Modell ein Bestseller wurde und sich immer größerer Popularität in vielen europäischen Städten erfreut.

A big, but not too much, construction is distinguished by stability. Thanks to its size, it doesn't disturb proportions in public space, so it can stand next to benches and bins, creating with them a coherent composition. Its universal application is the reason why H1200 has become our bestseller. It's popular in many European cities.

☰ 6 levels

🚚 355 - 660 kg

💧 668 l

⬆️ 1355 mm



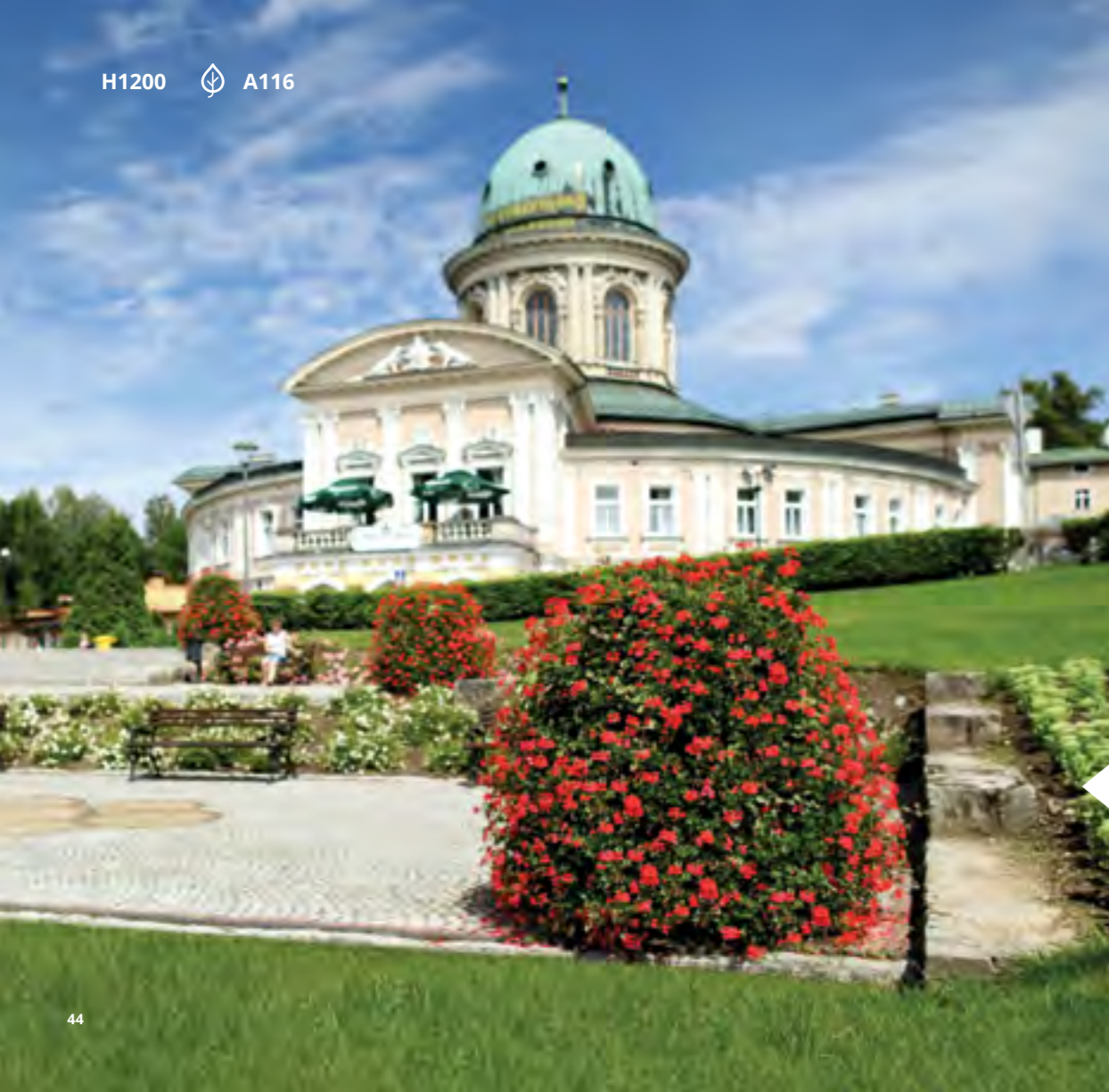

H 1200









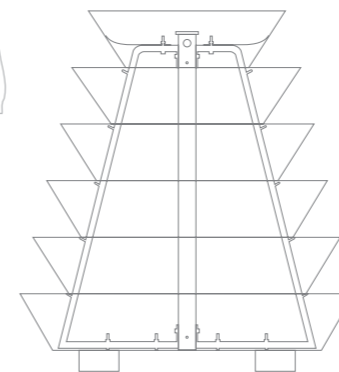
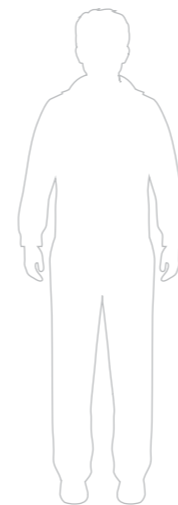

PARK

Parks spielen die Rolle der grünen Lungen der Stadt. Das ist auch ein perfekter Ort für Blumensäulen. Sorgfältig gewählte Bepflanzung lässt die wichtigsten Elemente der Komposition betonen. Wenn Sie nicht sicher sind, welche Blumen sich am besten bewähren, schauen Sie sich unsere Vorschläge an.

PARK

Park is considered green lung of the city. Despite the omnipresent greenery, it's also a great place for Flower Towers. If you match flowers and models properly, you can decorate park avenues and accentuate the most significant points.



	Anzahl der Ringe levels	▶	6
	Fassungsvermögen capacity	▶	668 l
	Gesamthöhe total height	▶	1355 mm
	Basisdurchmesser bottom diameter	▶	1200 mm
	Gewicht vor Bepflanzung weight before planting	▶	86 kg
	Gewicht nach Bepflanzung weight after planting	▶	355 - 660 kg
	Anzahl der Setzlinge estimated number of plants	▶	72 - 90
	Basisfarbe basic colour	▶	 030
	Farbvarianten available colours	▶	 032  033  034  035





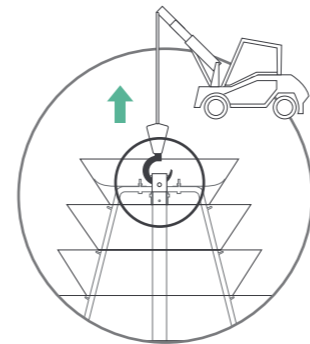

▶ TRANSPORTMODUL TRANSPORT MODULE

Funktionales System, das bequeme Entladung der bepflanztten Konstruktionen erleichtert und lässt das Risiko der Blumenbeschädigung reduzieren. Der sichere und widerstandsfähige Griff beschleunigt wesentlich den Prozess der Einführung von Produkten in den gewählten Raum.



The transport module consists of a safe and durable handle allowing to provide a decoration into urban space by using a special car. This functional system that makes unloading easier and accelerates the transport of constructions regardless their dimensions. It also guarantees no damage to flowers.



“*Catch it if you can!*”

Jeder mag bequeme und schnelle Lösungen. Jahrelange Erfahrung und wertvolle Hinweise unserer Kunden bilden eine gute Basis, um ein funktionales Transportmodul zu schaffen. Mithilfe eines hydraulischen Fahrzeugkrans kann man schnell und sicher bepflanzte Kaskadenkonstruktionen entladen oder umstellen.

All of us like comfortable and fast solutions. Years of experience and invaluable pieces of advice from our clients gave us foundations to create a functional transport system. Using a HDS crane, we can transport and unload stable and heavy constructions everywhere easily and safely.

Małgorzata Moskwik  
Kundenbetreuerin | Customer Service Specialist | +48 513 041 847 | malgorzata.moskwik@terra-pl.eu



ALTERNATIVE ZUR KLASSIK
ALTERNATIVE TO CLASSICS

www.terraflowertower.eu



KASKADENKONSTRUKTION
FLOWER TOWER

H 1200 $\frac{1}{2}$ $\frac{1}{4}$ $\frac{1}{2}$
ROUND



Dank origineller Form dieser Konstruktionen kann man Ecken oder Wände effektiv bepflanzen. Kaskadenkonstruktionen beheben kleine Fehler der Gebäudefassaden, verzieren Treppe, Eingänge oder andere schwer zugängliche Orte. Das ist der größte Vorteil dieser Modelle!

The innovative form of the construction was designed for corners and walls. Flower Towers cover the defects of facade, decorate stairs, gates, entrances and other problematic places. The arrangement of such places is the best advantage of these models.

☰ 6 levels



180 - 300 kg



314 l



1355 mm

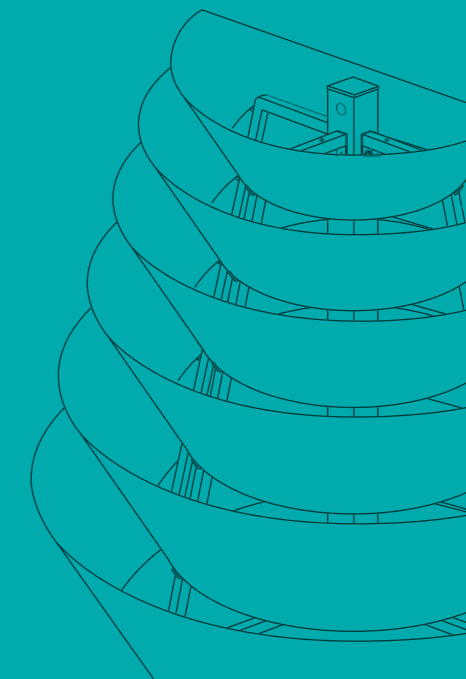



H1200 1/2  A102 + A105

EINGANG

Eine effektvolle Gestaltung des Gebäudeeingangs gehört nicht zu einfachen Aufgaben. Wenn Sie sich für Halbmodelle der Kaskadenkonstruktionen entscheiden, erzielen Sie einen interessanten Dekorationseffekt, ohne viel Platz einzunehmen. Klassische Modelle werden sich auch hervorragend präsentieren – sie ermöglichen die Einführung des natürlichen Elements dort, wo die Blumen von Natur aus nicht wachsen könnten. Bei entsprechender Wahl der Bepflanzung können Sie auch die Einzigartigkeit der Architektur betonen.

ENTRANCE

A proper decoration of an entrance isn't an easy task. You need to remember not to limit its functionality. If you decide for the half models of Flower Towers, you'll need a minimum of space to revive it. Moreover, if you add flowers in matching colours, you can accentuate the architectural style of a building.

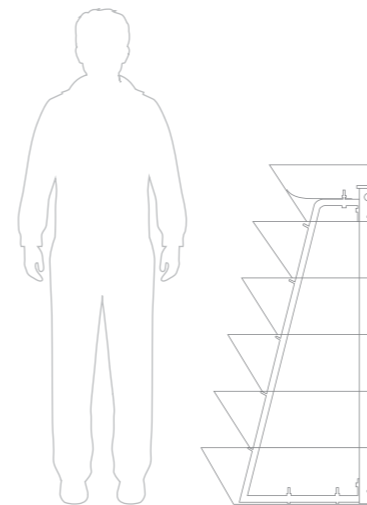

H 1200 ^{1/2}















eingang
entrance



markplatz
town square



gehweg
pavement

	Anzahl der Ringe levels	▶	6
	Fassungsvermögen capacity	▶	314 l
	Gesamthöhe total height	▶	1355 mm
	Basisdurchmesser bottom diameter	▶	1/2 1200 mm
	Gewicht vor Bepflanzung weight before planting	▶	60 kg
	Gewicht nach Bepflanzung weight after planting	▶	180 - 300 kg
	Anzahl der Setzlinge estimated number of plants	▶	40 - 50
	Basisfarbe basic colour	▶	 030
	Farbvarianten available colours	▶	 032  033  034  035

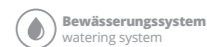



H1200 ½  A123

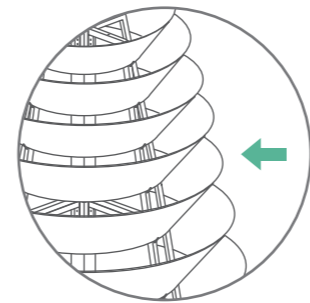

ZINKSCHICHT

▶ HOT DIP GALVANIZING COATING

Das Geheimnis der Witterungsbeständigkeit liegt im Prozess der Verzinkung, dem alle Modelle unterliegen. Zinkschicht schützt die Konstruktionen vor Korrosion und ermöglicht ihre jahrelange Nutzung. Feuerverzinkung bildet auch eine gute Basis für Pulverfarbbeschichtung.

The secret of resistance to weather conditions is the process of hot-dip galvanizing that each construction has to go through. Zinc coating protects from corrosion and allows to long-term use at the same time. Hot dip galvanizing coating is also a perfect base for powder coating.



“ For long years... ”

Seit über 15 Jahren verbinden wir sorgfältige Herstellung mit Innovation und bieten unseren Kunden Produkte höchster Qualität. Dank der Verbindung des Wissens von Produktionsexperten, Designern und Landschaftsarchitekten sind Terra-Produkte immer innovative Lösungen von höchster Qualität. Ihr wichtigster Vorteil ist die Beständigkeit, die aus hochwertigen Materialien und fortgeschrittenen Herstellungsmethoden resultiert.

We've been offering our clients the products of high quality since over 15 years by combining the workmanship and innovation. Thanks to the integration of the knowledge of production specialists, designers and landscape architects, our products are always innovative solutions of the highest level of safety and quality. Their most important feature is longevity achieved by choosing only the best materials and advanced methods of production.

Sławomir Jankowiak

Produktionsspezialist | Production Specialist | slawomir.jankowiak@terra-pl.eu

H 1200 ^{1/4}



	Anzahl der Ringe levels	▶	6
	Fassungsvermögen capacity	▶	157 l
	Gesamthöhe total height	▶	1355 mm
	Basisdurchmesser bottom diameter	▶	¼ 1200 mm
	Gewicht vor Bepflanzung weight before planting	▶	17 kg
	Gewicht nach Bepflanzung weight after planting	▶	96 - 150 kg
	Anzahl der Setzlinge estimated number of plants	▶	20 - 25
	Basisfarbe basic colour	▶	030
	Farbvarianten available colours	▶	032 033 034 035



H 1200 ^{1/2} ROUND

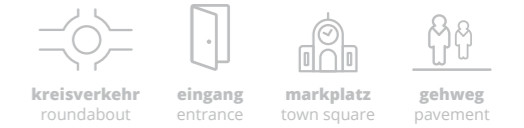

	Anzahl der Ringe levels	▶	6
	Fassungsvermögen capacity	▶	314 l
	Gesamthöhe total height	▶	1355 mm
	Basisdurchmesser bottom diameter	▶	½ 1200 mm
	Gewicht vor Bepflanzung weight before planting	▶	60 kg
	Gewicht nach Bepflanzung weight after planting	▶	180 - 300 kg
	Anzahl der Setzlinge estimated number of plants	▶	40 - 50
	Basisfarbe basic colour	▶	030
	Farbvarianten available colours	▶	032 033 034 035

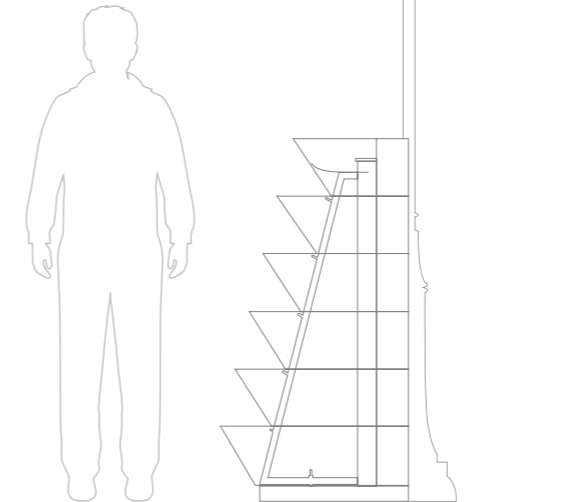
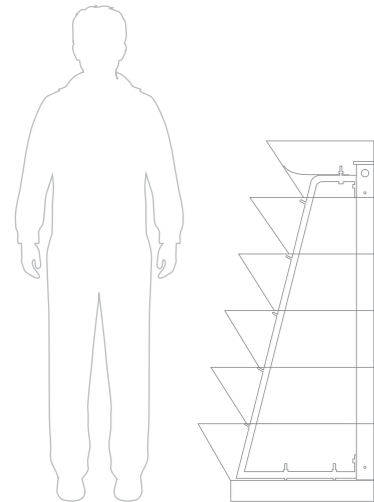



EIN ECHTER BLICKFANG
IMMOVABLE GIANT

www.terraflowertower.eu



KASKADENKONSTRUKTION
FLOWER TOWER

H 2000



Eines der höchsten Modelle, das sich mit sicherer und stabiler Konstruktion auszeichnet. Es bewährt sich als Orientierungspunkt oder bunter Akzent im Stadtraum. Solche Dekoration ist nicht zu übersehen!

One of the biggest models that is distinguished by its safe and stable construction. If you set it in the city centre, it can serve to citizens as an orientation point or a colourful and visible accent in public space. Its charm catches the eye.

☰ 9 levels



600 - 1150 kg



1168 l



1990 mm

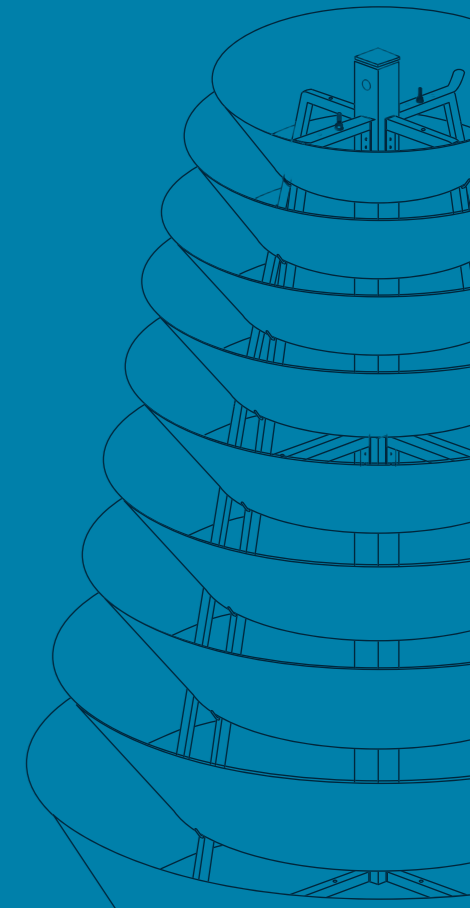



SPRINGBRUNNEN

Das Plätschern des Wassers ist nicht nur ein angenehmes und erholsames Geräusch für das Ohr – es ist auch feuchtigkeitsspendend. Wie kann man den Raum um ein so wichtiges Element der Architektur arrangieren? Nutzen Sie Blumensäulen H2000!

FOUNTAIN

Fountains make not only a sound pleasing to the ear but also are responsible for air hydration. This significant element of urban architecture is often seen in many cities. How to arrange such important space? Flower Towers H2000 are the best tool for this task.

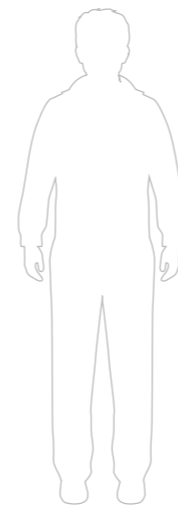

H 2000



kreisverkehr
roundabout



marktplatz
town square



park
park



springbrunnen
fountain



denkmal
monument

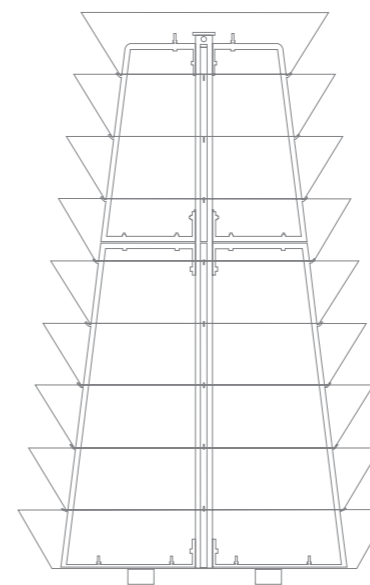

	Anzahl der Ringe levels	▶	9
	Fassungsvermögen capacity	▶	1168 l
	Gesamthöhe total height	▶	1990 mm
	Basisdurchmesser bottom diameter	▶	1200 mm
	Gewicht vor Bepflanzung weight before planting	▶	124 kg
	Gewicht nach Bepflanzung weight after planting	▶	600 - 1150 kg
	Anzahl der Setzlinge estimated number of plants	▶	110 - 130
	Basisfarbe basic colour	▶	 030
	Farbvarianten available colours	▶	 032  033  034  035



3 Jahre Garantie
3 year guarantee



Transportmodul
transport module



Bewässerungssystem
watering system



Diebstahlsicherung
anti-theft system



H2000  A102 + A105

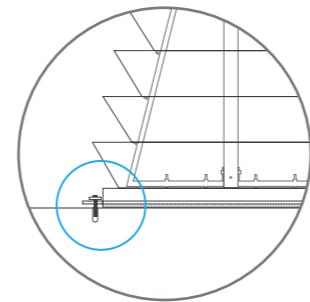

► **DIEBSTAHLSICHERUNG** ANTI-THEFT SYSTEM

Sichere und dauerhafte Lösung, die unsere Produkte vor Diebstahl oder Akte des Vandalismus schützt. Dank der stabilen und widerstandsfähigen Bodenbefestigung bleibt die Kaskaden-Blumenständerkonstruktion an ihrem Bestimmungsort.

The safe and solid solution that eliminates losses caused by robbery. The steel element of high quality guarantees effectiveness of anti-theft system. Stable and durable installation to the ground makes constructions immovable.



“**Sleep well!**”

Wir kümmern uns um Ihre Ruhe. Aus diesem Grund haben wir Diebstahlsicherung gestaltet. Nach vielen Jahren der Analyse und zahlreichen Gesprächen mit unseren Kunden schaffen wir Kaskadenkonstruktionen, die sich im Stadtraum bewähren. Beständiges Material und innovative Befestigung schrecken potentielle Vandalen und Diebe ab.

We want all our clients to sleep well, so the anti-theft system is our answer for their fear of vandalism and robbery. After many years of analyses, experience and consultations with clients, we managed to create constructions that are resistant to any threat. The durable material and innovative fixing system discourage potential vandals and thieves.

Małgorzata Trubiłowicz 

Kundenbetreuerin | Customer Service Specialist | +49 (0) 30.12 07 46 90 | malgorzata.trubilowicz@terra-de.eu



H 2000 ^{1/2}



	Anzahl der Ringe levels	▶	9
	Fassungsvermögen capacity	▶	584 l
	Gesamthöhe total height	▶	1990 mm
	Basisdurchmesser bottom diameter	▶	½ 1200 mm
	Gewicht vor Bepflanzung weight before planting	▶	62 kg
	Gewicht nach Bepflanzung weight after planting	▶	300 - 575 kg
	Anzahl der Setzlinge estimated number of plants	▶	55 - 65
	Basisfarbe basic colour	▶	030
	Farbvarianten available colours	▶	032 033 034 035

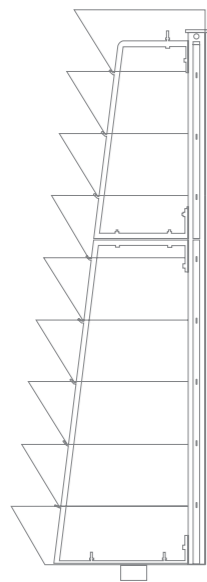
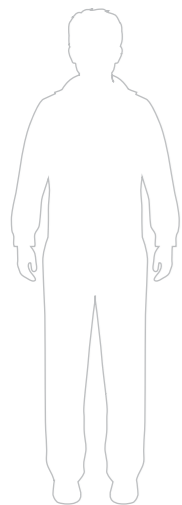
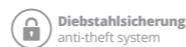
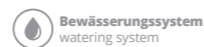

BLÜHENDE PYRAMIDE FLORAL PYRAMID

www.terraflowertower.eu



KASKADENKONSTRUKTION FLOWER TOWER

H 2400



In dieser riesigen Konstruktion passen bis 200 Setzlingen hinein. Sie lassen den Effekt der blühenden Kugel erzielen. Dank der großen Fläche können die angepflanzten Blumen verschiedene Muster wie z.B. Spirale oder Schachbrett annehmen.

This huge construction contains even up to 200 plants that create a beautiful flower tower after blooming. Thanks to such big surface, flowers can form various patterns, for example check or spiral. It depends only on your imagination. This huge volcano of flowers is immovable.

☰ 12 levels

📏 710 - 1300 kg

💧 1335 l

📏 2610 mm





STRASSE

Verwandeln Sie die Straße in einen bunten, einwohnerfreundlichen Ort! Kaskadenkonstruktionen H2400 bewährten sich dort, wo die Einführung grüner Elemente besonders problematisch ist. Sie beschränken keine Sicht, was für die Autofahrer sehr wichtig ist.

STREET

Turn a street into a colourful and friendly place in a very simple way. Flower Towers H2400 are the best at decorating the surroundings without nature and, what is the most important, they don't reduce visibility for drivers and pedestrians.

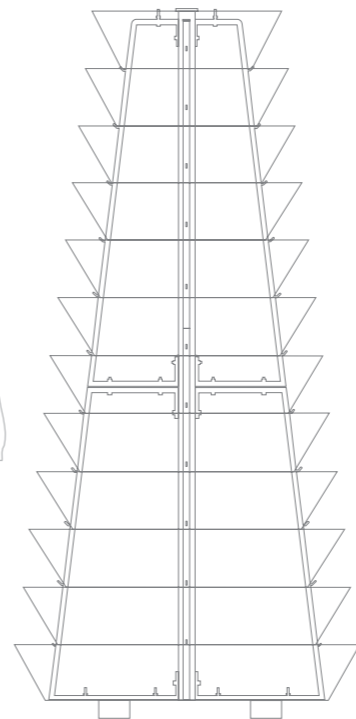
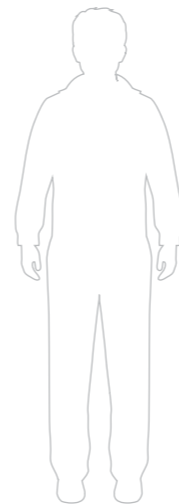

H 2400



	Anzahl der Ringe levels	▶	12
	Fassungsvermögen capacity	▶	1335 l
	Gesamthöhe total height	▶	2610 mm
	Basisdurchmesser bottom diameter	▶	1200 mm
	Gewicht vor Bepflanzung weight before planting	▶	147 kg
	Gewicht nach Bepflanzung weight after planting	▶	710 - 1300 kg
	Anzahl der Setzlinge estimated number of plants	▶	145 - 180
	Basisfarbe basic colour	▶	 030
	Farbvarianten available colours	▶	 032  033
			 034  035

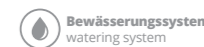



H2400  A114

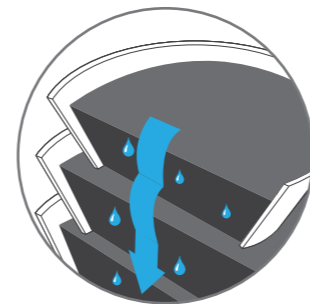

KASKADENSYSTEM

► CASCADE SYSTEM

Mit Patent geschütztes System offener Ringe. Als Basis jedes Modells dient die Bodenschale. Diese innovative Lösung erhöht wesentlich Effektivität und Qualität des Pflanzenanbaus. Da die einzelnen Schichten der Blumenständerkonstruktion keinen Boden besitzen, haben die Pflanzenwurzeln optimale Wachstumsbedingungen sowie entsprechende Wasser- und Luftmenge. Im Endeffekt entsteht eine üppige Bepflanzung, die die Stahlkonstruktion völlig bedeckt.

The patent system of open rings that creates a Flower Tower. The base of each model is a large bowl. This innovative solution gives plants unrestrained grow conditions, appropriate access to water and nutrients and also an optimal air circulation in root system. The effect is the improvement of effectiveness and quality of plants and the reduction of their loss. In result, the whole construction is covered with luxuriant flowers.



“ Let your city flourish... ”

Was ist ein Kaskadensystem? Das ist viel mehr als nur charakteristische Form unserer Produkte. Wir schufen das System, das den Setzlingen freie Entwicklung garantiert. Diese innovative, patentgeschützte Lösung erhöht Effektivität der Anpflanzungen. Diese Methode sichert den Pflanzen optimale Wasser- und Luftmenge und dem Wurzelsystem – freies Wachstum. Vertrauen Sie unserem Wissen und lassen Sie Ihre Stadt aufblühen...

What is a cascade system? It's something more than a characteristic shape of our products. We're the authors of a unique idea that guarantees unrestrained grow conditions of plants. This innovative and patent solution increases the quality of flowers. Thanks to the cascade arrangement of rings, an optimal amount of water and air is distributed to plants, and their root system can develop freely. Trust us and let your city flourish...

Urszula Jarczak 

Kundenbetreuerin | Customer Service Specialist | +49 (0) 30.12 07 46 90 | urszula.jarczak@terra-de.eu



IHRE HOHEIT NATUR
ITS HIGHNESS NATURE

www.terraflowertower.eu



KASKADENKONSTRUKTION
FLOWER TOWER

H 3000



Eine der höchsten Konstruktionen, die mit ihren Möglichkeiten begeistert. In 15 Stufen kann man über 200 Setzlinge anpflanzen, was einen originellen Dekorationseffekten erzielen lässt. Das ist ein interessanter, bunter Akzent und zugleich eine jahrelange Garantie der Sicherheit und Stabilität

One of the biggest constructions with huge possibilities. 15 levels can contain over 200 seedlings. It allows to achieve an interesting and colourful decoration which is safe and stable. The construction will last many years.

☰ 15 levels

📊 1400 - 1600 kg

💧 1390 l

📏 3105 mm

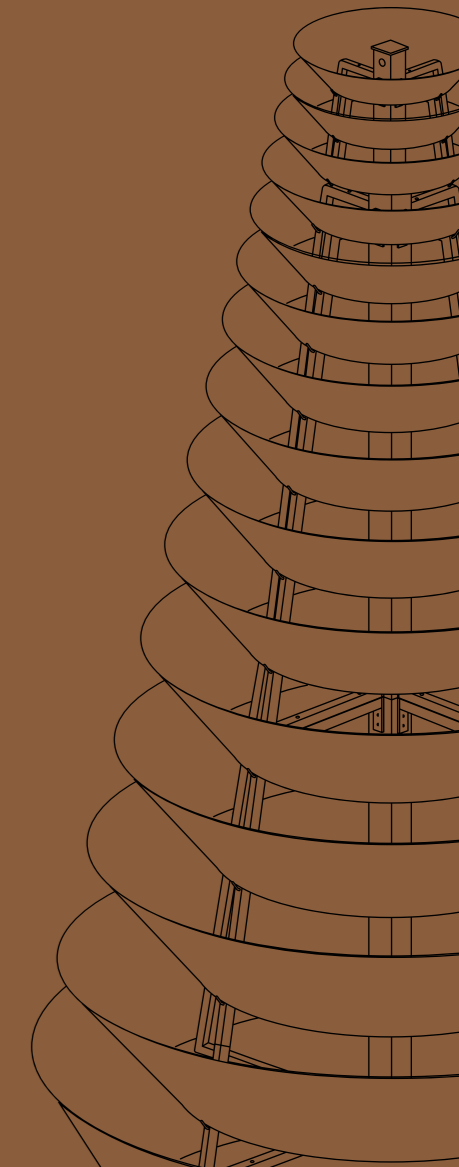



H3000  A116

H 3000

- 
marktplatz
town square
- 
park
park
- 
springbrunnen
fountain
- 
denkmal
monument

PLATZ IM STADTZENTRUM

Das Herz vieler europäischer Städte bildet ein riesiger, oft gepflasterter Platz. So ausgedehnte Fläche ohne natürlichen Boden ist eine große Herausforderung! Ihre Eintönigkeit können blumige Dekorationen brechen. Nur so große Blumenkonstruktionen wie H3000 können diese Aufgabe bewältigen.

COBBLESTONE SQUARE

A cobblestoned square is the heart of almost every Polish city. Such a big place without trees or flowers could be a real challenge! This monotony can be broken with floral decorations. The model H3000 will come up to your expectations.

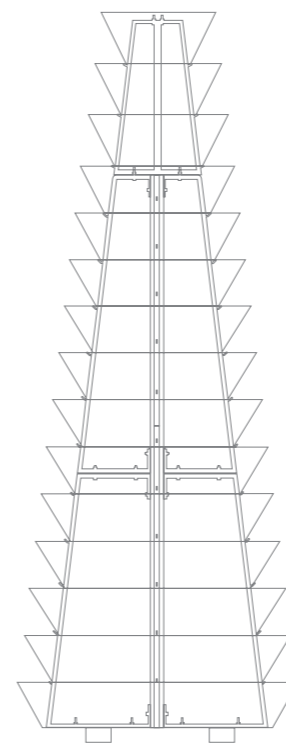
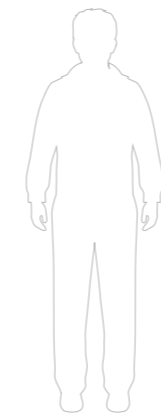

	Anzahl der Ringe levels	▶	15
	Fassungsvermögen capacity	▶	1390 l
	Gesamthöhe total height	▶	3105 mm
	Basisdurchmesser bottom diameter	▶	1200 mm
	Gewicht vor Bepflanzung weight before planting	▶	175 kg
	Gewicht nach Bepflanzung weight after planting	▶	1400 - 1600 kg
	Anzahl der Setzlinge estimated number of plants	▶	165 - 215
	Basisfarbe basic colour	▶	 030
	Farbvarianten available colours	▶	 032  033  034  035

-  3 Jahre Garantie
3 year guarantee
-  Transportmodul
transport module
-  Bewässerungssystem
watering system
-  Diebstahlsicherung
anti-theft system



H3000



A116

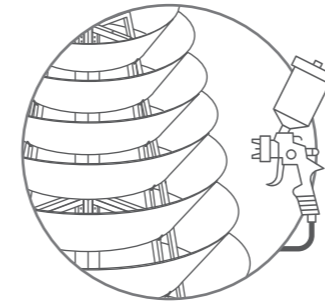

► PULVERFARBBSCHICHTUNG (DUPLEX) LACQUER COLOUR DUPLEX SYSTEM

Attraktives Aussehen und interessanter Dekorationseffekt gehören zu den größten Vorteilen der Kaskadenkonstruktionen. Über ihre Ästhetik entscheidet in hohem Maße die Pulverfarbe, die Stahlelemente der Konstruktion beschichtet. Ihre Anwendung resultiert aber nicht aus ästhetischen Gründen – die Pulverfarbschicht, die das Auge erfreut, bildet zugleich ein zusätzlicher Korrosionsschutz.

The biggest advantages of the Flower Towers are a good appearance and an impressive effect. Such a result is possible thanks to a lacquered layer that covers our constructions. Its application also gives a long lasting protection against corrosion.



“ **Big can do more!**

In unser Angebot haben wir noch größere Modelle der Kaskadenkonstruktionen eingeführt. 3 Meter hoher Blumenturm eröffnet viele Arrangementsmöglichkeiten und lässt die Farben beliebig komponieren. Wichtig ist, dass das Modell H3000 trotz seiner Größe stabil bleibt. Aus diesem Grund ist er eine sichere Dekoration für jeden Stadtraum.

We have recently added even larger Flower Towers. Despite its size, the model H3000 is stable but still a very safe decoration perfect for urban space arrangement.

Katarzyna Wojciechowska  

Kundenbetreuerin | Customer Service Specialist | +48 667 107 777 | katarzyna.wojciechowska@terra-pl.eu



EFFEKT EINER BLUMIGEN KUGEL
THE EFFECT OF A FLORAL SPHERE

www.terraflowertower.eu



KASKADENKONSTRUKTION
FLOWER TOWER

W 600



Dank innovativem Kaskadensystem mit doppeltem Boden sowie der Pulverfarbschicht unterscheiden sich diese Konstruktionen von anderen Blumenampeln. Verschiedene Befestigungsarten ermöglichen die Anpassung des Modells W600 an jede Straßenlaterne. Im Endeffekt entsteht eine einzigartige, blumige Kugel.

An innovative cascade system with double bottom and powder coating as a basic version – these features distinguish W600 among similar decorations for lamps. Additionally, various kinds of fixing make this model suitable for each type of a lamp. The result is the effect of a floral sphere.

≡ 3 levels

 50 - 70 kg

 60 l

 550 mm

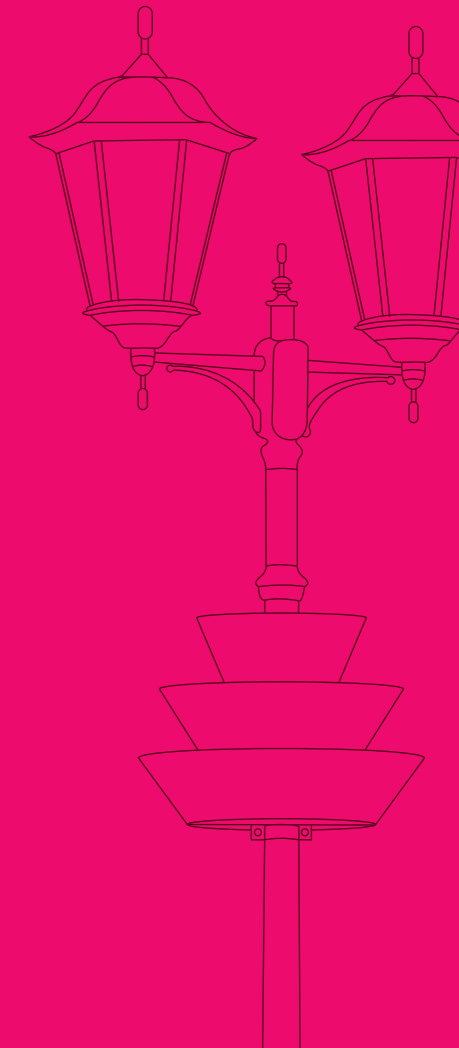



GRÜNANLAGE

In jeder Stadt befinden sich zahlreiche Grünanlage, die man auf verschiedene Art und Weise arrangieren kann. Wenn Sie den Platz auf dem Bürgersteig sparen wollen, verwenden Sie als Basis der Dekoration die Straßenlaternen. Betonen Sie ihre Schönheit mit blumigen Kugeln, die Sie mithilfe hängender Kaskadenkonstruktionen W600 schaffen können.

SQUARE

Squares worth arranging are in every city. If you don't want to take the space on pavements, use street lamps. Accentuate them thanks to floral spheres created by constructions W600.

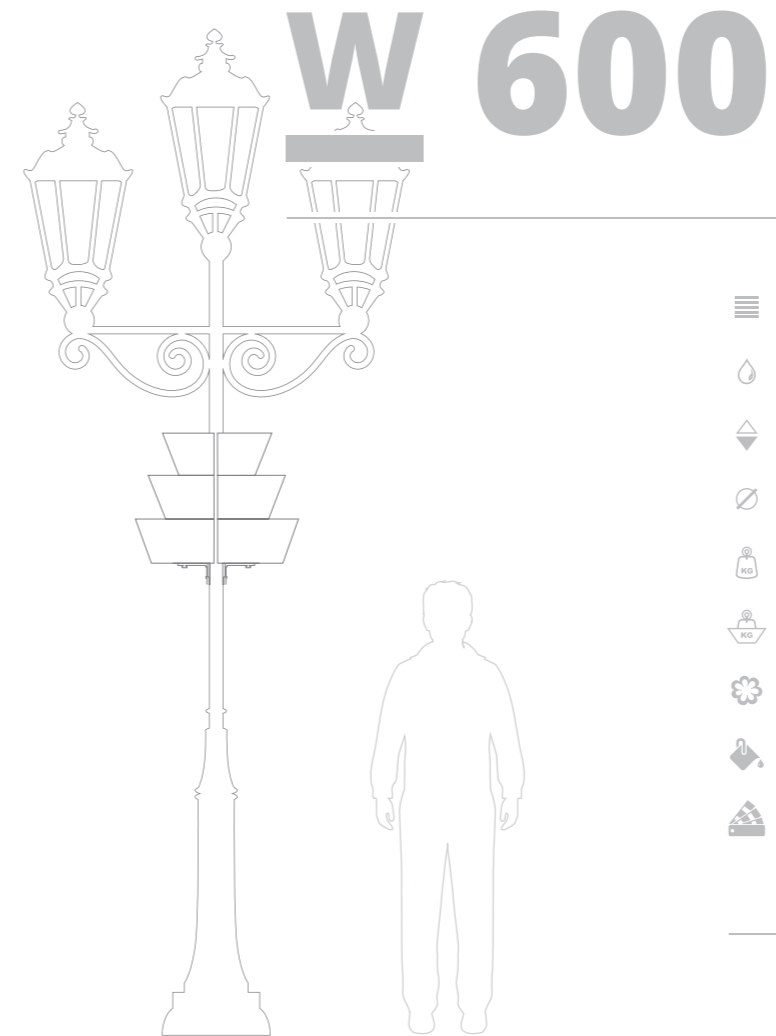

marktplatz
town square



park
park



straße
street



gehweg
pavement

	Anzahl der Ringe levels	▶	3
	Fassungsvermögen capacity	▶	60 l
	Gesamthöhe total height	▶	550 mm
	Basisdurchmesser bottom diameter	▶	600 mm
	Gewicht vor Bepflanzung weight before planting	▶	17 kg
	Gewicht nach Bepflanzung weight after planting	▶	50 - 70 kg
	Anzahl der Setzlinge estimated number of plants	▶	30 - 40
	Basisfarbe basic colour	▶	032
	Farbvarianten available colours	▶	033 034
			035



3 Jahre Garantie
3 year guarantee



Bewässerungssystem
watering system



Diebstahlsicherung
anti-theft system

W 600/2

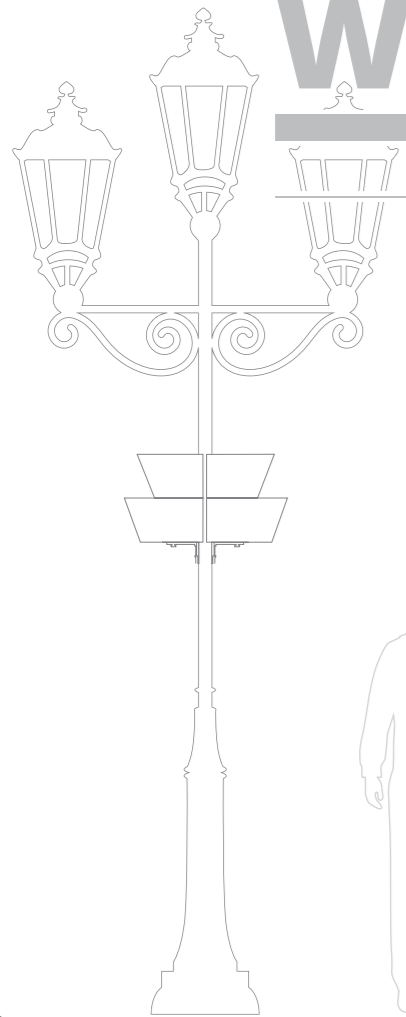

	Anzahl der Ringe levels	▶	2
	Fassungsvermögen capacity	▶	45 l
	Gesamthöhe total height	▶	330 mm
	Basisdurchmesser bottom diameter	▶	600 mm
	Gewicht vor Bepflanzung weight before planting	▶	13 kg
	Gewicht nach Bepflanzung weight after planting	▶	40 - 60 kg
	Anzahl der Setzlinge estimated number of plants	▶	25 - 35
	Basisfarbe basic colour	▶	032
	Farbvarianten available colours	▶	033 034 035

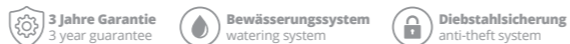

W 600/1

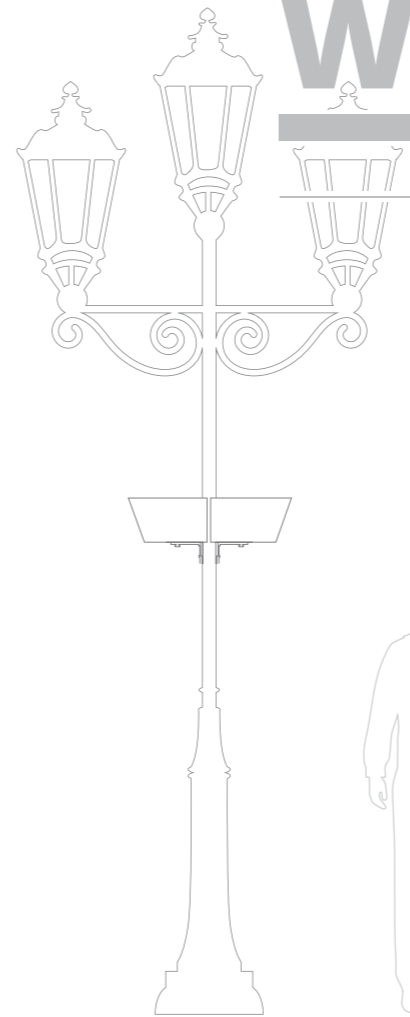

	Anzahl der Ringe levels	▶	1
	Fassungsvermögen capacity	▶	30 l
	Gesamthöhe total height	▶	175 mm
	Basisdurchmesser bottom diameter	▶	600 mm
	Gewicht vor Bepflanzung weight before planting	▶	8 kg
	Gewicht nach Bepflanzung weight after planting	▶	30 - 50 kg
	Anzahl der Setzlinge estimated number of plants	▶	15 - 20
	Basisfarbe basic colour	▶	032
	Farbvarianten available colours	▶	033 034 035

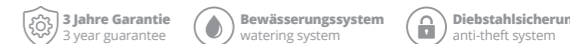

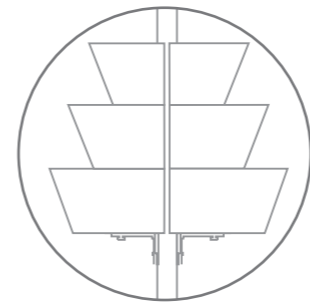

► BEFESTIGUNGEN FÜR JEDE ART DER STRASSENLATERNEN

FIXING SUITABLE FOR EVERY LAMP

Breite Befestigungspalette ermöglicht die Montage der Blumenampel an fast jede Straßenlaterne. Dank der speziellen Konstruktion sind hängende Dekorationen eine sichere Lösung, die Ästhetik des Raumes verbessern lässt.



There are so many types of fixing that hanging constructions can be hanged on almost every street lamp. A precisely planned construction makes this decoration safe and aesthetic.



“*Having a head in the flowers...*”

Um die Bedürfnisse unserer Kunden zu befriedigen, haben wir hängende Kaskadenkonstruktionen geschaffen. Diese patentgeschützten Produkte sind einzige solche Blumenbehälter in ganz Europa. Voll bepflanzt lassen sie einen außergewöhnlichen Effekt der blumigen Kugel erzielen. Spezielles Befestigungssystem lässt die Blumenampeln an beliebige Straßenlaternen mit verschiedenen Formen und Größen montieren. Es garantiert die Sicherheit und schützt die Außenschicht der Laterne.

Thinking about small urban architecture, we created the models designed for lamps. These patent products are the only such containers for flowers in Europe. When they are fully planted, they look like floral spheres. The advanced fixing system guarantees that these models can hang on almost every lamp regardless its shape and size. You can be sure that a lamp post won't be damaged.

Małgorzata Moskwik  
Kundenbetreuerin | Customer Service Specialist | +48 513 041 847 | malgorzata.moskwik@terra-pl.eu



Kaufen Sie keine Katze im Sack

Bestellen Sie eine kostenlose Visualisierung und schauen Sie sich an, wie sich Ihre Stadt ändern kann.

Wir wissen, wie schwer das entsprechende Arrangement des Stadtraumes ist. Um Ihre Arbeit zu erleichtern, schlagen wir Ihnen eine kostenlose Visualisierung vor. Unsere Ideen helfen Ihnen bei der Wahl der Produkte und der Bepflanzung.

Schicken Sie uns per visualisation@terraflowertower.eu die Fotos der Orte, die Sie verändern möchten. Unsere Landschaftsarchitekten finden optimale Lösungen für Ihren Raum und schaffen eine kostenlose Visualisierung. Im Endeffekt bekommen Sie ein komplexes Projekt, dank dessen Sie sich das Ausmaß der geplanten Änderungen anschauen. Die Entscheidung liegt bei Ihnen!

Dominik Osyczka 

Landschaftsarchitekt | Landscape architect | dominik.osyczka@terra-pl.eu



Don't buy sight unseen

Order a free visualisation and see how your city could change.

We know how hard it is to prepare an urban space arrangement that will be outstanding and interesting. We want to make your work easier, so we offer you a free visualisation of changes in given places. Prepared projects and ideas facilitate the later selection of products and flowers.

Send the photos of places you want to change to us on visualisation@terraflowertower.eu. Our landscape architects will suggest you the best solutions and create an individual project. The result of our work will be the brand new design of your city. Now it's time for you decision...

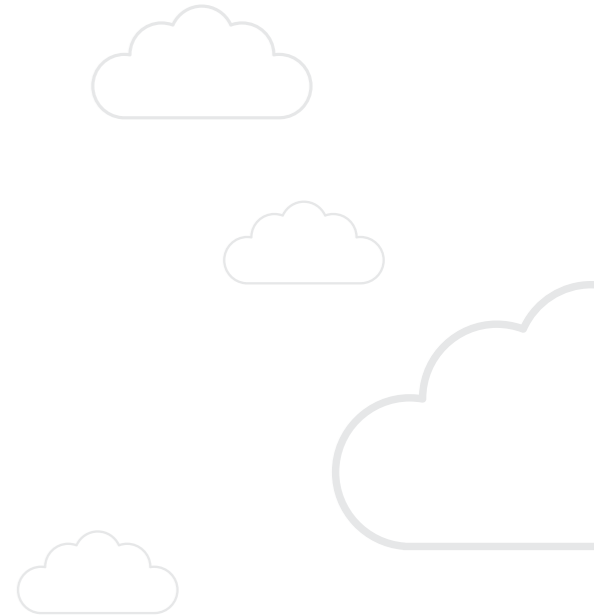



It's Christmas time!

Prepare Flower Towers for Christmas.

Im Sommer schmücken die Blumentürme viele Städte. Mit dem Ende der warmen Tage beginnt ihr Charme jedoch zu verblassen. Sie können sich aber auch im Winter als Dekoration der öffentlichen Plätze bewahren. Eine Lösung dafür sind die Terra-Weihnachtsüberzüge. Einerseits verschönern sie die Umgebung, andererseits lösen sie das Problem der Lagerung der Konstruktionen in der Winterzeit.

Flower Towers embellish cities in summer but along with the end of warm days, their charm begins to fade. However, nothing's an obstacle in the way of decorating urban space in winter. Use Terra Christmas covers on constructions to create the festive mood. They will not only make your city beautiful during winter time but also eliminate the problem of storing summer decorations.

Terra
Christmas

HOHE WIDERSTANDSFÄHIGKEIT
High resistance

HALTBAR UND STABIL
Strong and stable

EINFACHE MONTAGE
Easy fixing

HÖCHSTE QUALITÄT
The highest quality

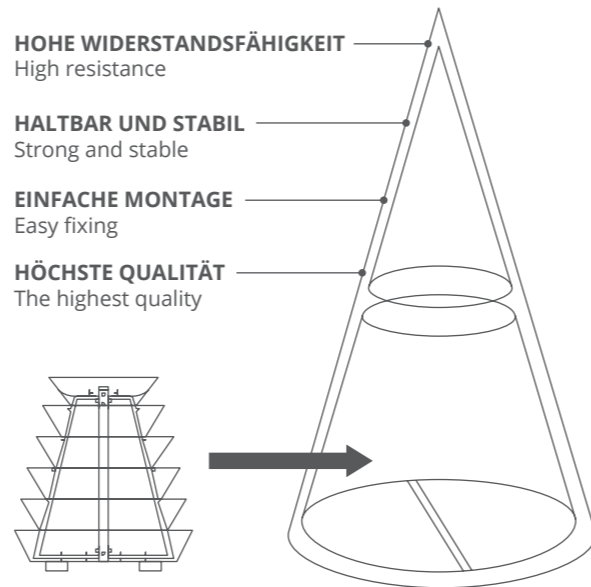

Marcin Brożek 
Team Leader | marcin.brozek@terra-pl.eu



H1200 + Terra Christmas Tree 300 | W600 + Terra Christmas Ball 70 | X-Mas Ball 70 | Rudolf

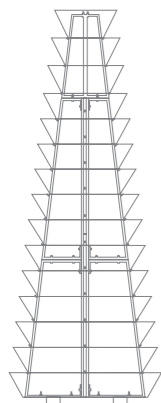

H 3000

- Anzahl der Ringe** levels ▶ 15
- Fassungsvermögen** capacity ▶ 1390 l
- Gesamthöhe** total height ▶ 3105 mm
- Basisdurchmesser** bottom diameter ▶ 1200 mm
- Gewicht vor Bepflanzung** weight before planting ▶ 175 kg
- Gewicht nach Bepflanzung** weight after planting ▶ 1400 - 1600 kg
- Anzahl der Setzlinge** estimated number of plants ▶ 165 - 215
- Basisfarbe** basic colour ▶ 030
- Farbvarianten** available colours ▶ 032 033 034 035

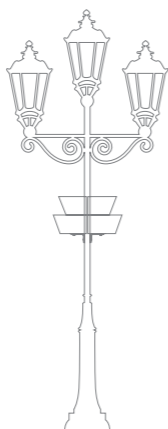

W 600/2

- Anzahl der Ringe** levels ▶ 2
- Fassungsvermögen** capacity ▶ 45 l
- Gesamthöhe** total height ▶ 330 mm
- Basisdurchmesser** bottom diameter ▶ 600 mm
- Gewicht vor Bepflanzung** weight before planting ▶ 13 kg
- Gewicht nach Bepflanzung** weight after planting ▶ 40 - 60 kg
- Anzahl der Setzlinge** estimated number of plants ▶ 25 - 35
- Basisfarbe** basic colour ▶ 032
- Farbvarianten** available colours ▶ 035 034 033

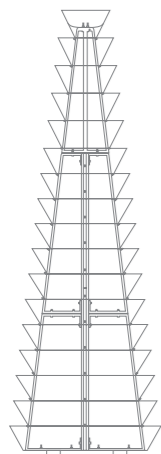

H 3400

- Anzahl der Ringe** levels ▶ 17
- Fassungsvermögen** capacity ▶ 1490 l
- Gesamthöhe** total height ▶ 3435 mm
- Basisdurchmesser** bottom diameter ▶ 1200 mm
- Gewicht vor Bepflanzung** weight before planting ▶ 190 kg
- Gewicht nach Bepflanzung** weight after planting ▶ 1800 - 2000 kg
- Anzahl der Setzlinge** estimated number of plants ▶ 185 - 230
- Basisfarbe** basic colour ▶ 030
- Farbvarianten** available colours ▶ 032 033 034 035

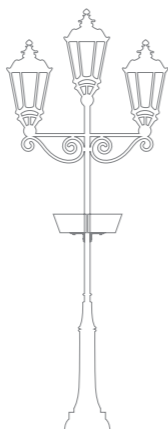

W 600/1

- Anzahl der Ringe** levels ▶ 1
- Fassungsvermögen** capacity ▶ 30 l
- Gesamthöhe** total height ▶ 175 mm
- Basisdurchmesser** bottom diameter ▶ 600 mm
- Gewicht vor Bepflanzung** weight before planting ▶ 8 kg
- Gewicht nach Bepflanzung** weight after planting ▶ 30 - 50 kg
- Anzahl der Setzlinge** estimated number of plants ▶ 15 - 20
- Basisfarbe** basic colour ▶ 032
- Farbvarianten** available colours ▶ 035 034 033



H 700

- Anzahl der Ringe** levels ▶ 3
- Fassungsvermögen** capacity ▶ 167 l
- Gesamthöhe** total height ▶ 720 mm
- Basisdurchmesser** bottom diameter ▶ 750 mm
- Gewicht vor Bepflanzung** weight before planting ▶ 35 kg
- Gewicht nach Bepflanzung** weight after planting ▶ 105 - 160 kg
- Anzahl der Setzlinge** estimated number of plants ▶ 30 - 40
- Basisfarbe** basic colour ▶ 030
- Farbvarianten** available colours ▶ 032 033 034 035



H 750

- Anzahl der Ringe** levels ▶ 3
- Fassungsvermögen** capacity ▶ 373 l
- Gesamthöhe** total height ▶ 740 mm
- Basisdurchmesser** bottom diameter ▶ 1200 mm
- Gewicht vor Bepflanzung** weight before planting ▶ 58 kg
- Gewicht nach Bepflanzung** weight after planting ▶ 190 - 370 kg
- Anzahl der Setzlinge** estimated number of plants ▶ 40 - 50
- Basisfarbe** basic colour ▶ 030
- Farbvarianten** available colours ▶ 032 033 034 035

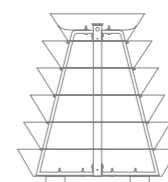

H 1100

- Anzahl der Ringe** levels ▶ 6
- Fassungsvermögen** capacity ▶ 125 l
- Gesamthöhe** total height ▶ 1010 mm
- Basisdurchmesser** bottom diameter ▶ 600 mm
- Gewicht vor Bepflanzung** weight before planting ▶ 30 kg
- Gewicht nach Bepflanzung** weight after planting ▶ 90 - 120 kg
- Anzahl der Setzlinge** estimated number of plants ▶ 32 - 50
- Basisfarbe** basic colour ▶ 032
- Farbvarianten** available colours ▶ 035 034 033

H 1200

- Anzahl der Ringe** levels ▶ 6
- Fassungsvermögen** capacity ▶ 668 l
- Gesamthöhe** total height ▶ 1355 mm
- Basisdurchmesser** bottom diameter ▶ 1200 mm
- Gewicht vor Bepflanzung** weight before planting ▶ 86 kg
- Gewicht nach Bepflanzung** weight after planting ▶ 355 - 660 kg
- Anzahl der Setzlinge** estimated number of plants ▶ 72 - 90
- Basisfarbe** basic colour ▶ 030
- Farbvarianten** available colours ▶ 032 033 034 035



H 1200 ¹/₂

	Anzahl der Ringe levels	▶ 6
	Fassungsvermögen capacity	▶ 314 l
	Gesamthöhe total height	▶ 1355 mm
	Basisdurchmesser bottom diameter	▶ ½ 1200 mm
	Gewicht vor Bepflanzung weight before planting	▶ 60 kg
	Gewicht nach Bepflanzung weight after planting	▶ 180 - 300 kg
	Anzahl der Setzlinge estimated number of plants	▶ 40 - 50
	Basisfarbe basic colour	▶ 030
	Farbvarianten available colours	▶ 032 033 034 035

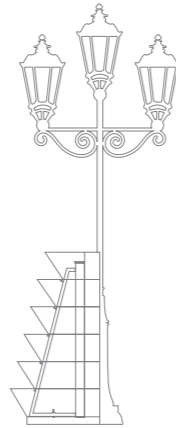

H 1200 ¹/₂ ROUND

	Anzahl der Ringe levels	▶ 6
	Fassungsvermögen capacity	▶ 314 l
	Gesamthöhe total height	▶ 1355 mm
	Basisdurchmesser bottom diameter	▶ ½ 1200 mm
	Gewicht vor Bepflanzung weight before planting	▶ 60 kg
	Gewicht nach Bepflanzung weight after planting	▶ 180 - 300 kg
	Anzahl der Setzlinge estimated number of plants	▶ 40 - 50
	Basisfarbe basic colour	▶ 030
	Farbvarianten available colours	▶ 032 033 034 035



H 2000 ¹/₂

	Anzahl der Ringe levels	▶ 9
	Fassungsvermögen capacity	▶ 584 l
	Gesamthöhe total height	▶ 1990 mm
	Basisdurchmesser bottom diameter	▶ ½ 1200 mm
	Gewicht vor Bepflanzung weight before planting	▶ 62 kg
	Gewicht nach Bepflanzung weight after planting	▶ 300 - 575 kg
	Anzahl der Setzlinge estimated number of plants	▶ 55 - 65
	Basisfarbe basic colour	▶ 030
	Farbvarianten available colours	▶ 032 033 034 035



H 2400 ¹/₂

	Anzahl der Ringe levels	▶ 12
	Fassungsvermögen capacity	▶ 667 l
	Gesamthöhe total height	▶ 2610 mm
	Basisdurchmesser bottom diameter	▶ ½ 1200 mm
	Gewicht vor Bepflanzung weight before planting	▶ 103 kg
	Gewicht nach Bepflanzung weight after planting	▶ 355 - 650 kg
	Anzahl der Setzlinge estimated number of plants	▶ 80 - 100
	Basisfarbe basic colour	▶ 030
	Farbvarianten available colours	▶ 032 033 034 035



H 1200 ¹/₄

	Anzahl der Ringe levels	▶ 6
	Fassungsvermögen capacity	▶ 157 l
	Gesamthöhe total height	▶ 1335 mm
	Basisdurchmesser bottom diameter	▶ ¼ 1200 mm
	Gewicht vor Bepflanzung weight before planting	▶ 17 kg
	Gewicht nach Bepflanzung weight after planting	▶ 96 - 150 kg
	Anzahl der Setzlinge estimated number of plants	▶ 20 - 25
	Basisfarbe basic colour	▶ 030
	Farbvarianten available colours	▶ 032 033 034 035



H 2000

	Anzahl der Ringe levels	▶ 9
	Fassungsvermögen capacity	▶ 1168 l
	Gesamthöhe total height	▶ 1990 mm
	Basisdurchmesser bottom diameter	▶ 1200 mm
	Gewicht vor Bepflanzung weight before planting	▶ 124 kg
	Gewicht nach Bepflanzung weight after planting	▶ 600 - 1150 kg
	Anzahl der Setzlinge estimated number of plants	▶ 110 - 130
	Basisfarbe basic colour	▶ 030
	Farbvarianten available colours	▶ 032 033 034 035



H 2400

	Anzahl der Ringe levels	▶ 12
	Fassungsvermögen capacity	▶ 1335 l
	Gesamthöhe total height	▶ 2610 mm
	Basisdurchmesser bottom diameter	▶ 1200 mm
	Gewicht vor Bepflanzung weight before planting	▶ 147 kg
	Gewicht nach Bepflanzung weight after planting	▶ 710 - 1300 kg
	Anzahl der Setzlinge estimated number of plants	▶ 145 - 180
	Basisfarbe basic colour	▶ 030
	Farbvarianten available colours	▶ 032 033 034 035

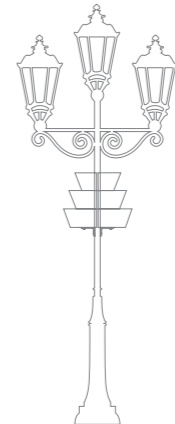

W 600

	Anzahl der Ringe levels	▶ 3
	Fassungsvermögen capacity	▶ 60 l
	Gesamthöhe total height	▶ 550 mm
	Basisdurchmesser bottom diameter	▶ 600 mm
	Gewicht vor Bepflanzung weight before planting	▶ 17 kg
	Gewicht nach Bepflanzung weight after planting	▶ 50 - 70 kg
	Anzahl der Setzlinge estimated number of plants	▶ 30 - 40
	Basisfarbe basic colour	▶ 032
	Farbvarianten available colours	▶ 035 034 033

						
Anzahl der Ringe levels	Fassungsvermögen capacity [L]	Gesamthöhe total height [MM]	Durchmesser bottom [MM]	Nettogewicht net weight [KG]	Bruttogewicht gross weight [KG]	Anzahl der Setzlinge plants

H 700	3	167	720	750	35	105 - 160	30 - 40
H 750	3	373	740	1200	58	190 - 370	40 - 50
H 1100	6	125	1010	600	30	90 - 120	32 - 50
H 1200	6	668	1355	1200	86	355 - 660	72 - 90
H 1200 ^{1/2}	6	314	1355	½ 1200	60	180 - 300	40 - 50
H 1200 ^{1/4}	6	157	1355	¼ 1200	17	96 - 150	20 - 25
H 1200 ^{1/2} ROUND	6	314	1355	½ 1200	60	180 - 300	40 - 50
H 2000	9	1168	1990	1200	124	600 - 1150	110 - 130

						
Anzahl der Ringe levels	Fassungsvermögen capacity [L]	Gesamthöhe total height [MM]	Durchmesser bottom [MM]	Nettogewicht net weight [KG]	Bruttogewicht gross weight [KG]	Anzahl der Setzlinge plants

H 2000 ^{1/2}	9	584	1990	½ 1200	62	300 - 575	55 - 65
H 2400	12	1335	2610	1200	147	710 - 1300	145 - 180
H 2400 ^{1/2}	12	667	2610	1200	103	355 - 650	80 - 100
H 3000	15	1390	3105	1200	175	1400 - 1600	165 - 215
H 3400	17	1490	3435	1200	190	1800 - 2000	185 - 230
W 600/2	1	30	175	600	8	30 - 50	15 - 20
W 600/1	2	45	330	600	13	40 - 60	25 - 35
W 600	3	60	550	600	17	50 - 70	30 - 40

Got questions?

Urszula Jarczak

Betreuerin deutschsprachiger Kunden | German Speaking Customer Service Specialist
+49 (0) 30.12 07 46 90 | urszula.jarczak@terra-de.eu

Małgorzata Trubiłowicz

Betreuerin deutschsprachiger Kunden | German Speaking Customer Service Specialist
+49 (0) 30.12 07 46 90 | malgorzata.trubilowicz@terra-de.eu

Małgorzata Moskwik

Betreuerin englisch- und russischsprachiger Kunden | English and Russian Speaking Customer Service Specialist
+48 513 041 847 | malgorzata.moskwik@terra-pl.eu

Katarzyna Wojciechowska

Betreuerin englisch- und spanischsprachiger Kunden | English and Spanish Speaking Customer Service Specialist
+48 667 107 777 | katarzyna.wojciechowska@terra-pl.eu



download
the catalogue

Terra Group behält sich das Recht zur Modifizierung dargestellter Produkte ohne vorherige Ankündigung vor. Detaillierte Informationen finden Sie unter www.terraflowertower.eu sowie bei unserem Kundenservice.

Terra Group reserves the right to modify presented products without warning. Find more details on www.terraflowertower.eu or contact our Customer Service.



Terra Group, ul. Wrocławska 17B, 65-427 Zielona Góra, tel.: + 48 68 455 62 69, e-mail: info@terra-pl.eu